

USER'S MANUAL

RCO-6000 Series

Superior Fanless Embedded System



Table of Contents

Prefaces	04
Revision	04
Disclaimer	04
Copyright Notice	04
Trademarks Acknowledgment	04
Environmental Protection Announcement	04
Safety Precautions	05
Technical Support and Assistance	06
Conventions Used in this Manual	06
Package Contents	07
Ordering Information	07
Optional Accessory	09
Chapter 1 Product Introductions	10
1.1 Overview	11
1.1.1 Key Feature	11
1.2 Hardware Specification	12
1.3 System I/O	13
1.3.1 RCO-6000	13
1.3.2 RCO-6000-4L(P)	15
1.3.3 RCO-6000-4L(P)-M12	17
1.3.4 RCO-6000-8L(P)	19
1.3.5 RCO-6000-8L(P)-M12	21
1.3.6 RCO-6011E(P)	23
1.3.7 RCO-6011E(P)-4L(P)	25
1.3.8 RCO-6011E(P)-4L(P)-M12	27
1.3.9 RCO-6011E(P)-8L(P)	29
1.3.10 RCO-6011E(P)-8L(P)-M12	31
1.3.11 RCO-6022EE(PP/PE)	33
1.3.12 RCO-6022EE(PP/PE)-4L(P)	35
1.3.13 RCO-6022EE(PP/PE)-4L(P)-M12	37
1.3.14 RCO-6022EE(PP/PE)-8L(P)	39
1.3.15 RCO-6022EE(PP/PE)-8L(P)-M12	41
1.4 Mechanical Dimension	43
1.4.1 RCO-6000 / RCO-6000-4L(P) / RCO-6000-4L(P)-M12 / RCO-6000-8L(P) / RCO-6000-8L(P)-M12	43
1.4.2 RCO-6011E / RCO-6011E-4L(P) / RCO-6011E-4L(P)-M12 / RCO-6011E-8L(P) / RCO-6011E-8L(P)-M12 / RCO-6011P / RCO-6011P-4L(P) / RCO-6011P-4L(P)-M12 / RCO-6011P-8L(P) / RCO-6011P-8L(P)-M12	44
1.4.3 RCO-6022EE / RCO-6022EE-4L(P) / RCO-6022EE-4L(P)-M12 / RCO-6022EE-8L(P) / RCO-6022EE-8L(P)-M12 / RCO-6022PP / RCO-6022PP-4L(P) / RCO-6022PP-4L(P)-M12 / RCO-6022PP-8L(P) / RCO-6022PP-8L(P)-M12 / RCO-6022PE / RCO-6022PE-4L(P) / RCO-6022PE-4L(P)-M12 / RCO-6022PE-8L(P) / RCO-6022PE-8L(P)-M12	45

Chapter 2	Switches and Connectors	46
2.1	Switch and connector Locations	47
2.1.1	Top View	47
2.1.2	Bottom View	48
2.2	Connector / Switch Definition	49
2.3	Switch Definitions	50
2.4	Connector Definitions	50
Chapter 3	System Setup	66
3.1	Set torque force to 3.5 kgf-cm to execute all the screwing and unscrewing	67
3.2	Removing chassis bottom cover	67
3.3	Removing PCIe/PCI expansion module	68
3.4	Removing chassis top cover	69
3.5	Installing SODIMM	70
3.6	Installing CPU	71
3.7	Installing mini PCIe card / mSATA	76
3.8	Installing antenna	77
3.9	Assembly chassis top cover	79
3.10	Installing HDD on internal SATA HDD bay	81
3.11	Installing HDD on removable SATA HDD bay	83
3.12	Installing PCIe/PCI expansion card	84
3.13	Assemble PCIe/PCI expansion module	86
3.14	Assemble chassis bottom cover	87
3.15	Installing SIM card	88
3.16	Installing wall mount kit	90
Chapter 4	BIOS Setup	91
4.1	BIOS Introduction	92
4.2	Main Setup	93
4.3	Advanced Setup	94
4.3.1	CPU Configuration	95
4.3.2	PCH-FW Configuration	96
4.3.3	SATA And RST Configuration	97
4.3.4	RST (UEFI RAID) Configuration	98
4.3.5	Trusted Computing	100
4.3.6	ACPI Settings	101
4.3.7	NCT6106D Super IO Configuration	102
4.3.8	NCT6106D HW Monitor	105
4.3.9	Serial Port Console Redirection	106
4.3.10	Network Stack Configuration	106
4.3.11	CSM Configuration	107
4.3.12	USB Configuration	108
4.4	Chipset	109
4.4.1	System Agent (SA) Configuration	109
4.4.2	PCH-IO Configuration	112
4.5	Security	115
4.6	Boot	116
4.7	Save & Exit	117
Appendix WDT & GPIO	118
	WDT Sample Code	119
	GPIO Sample Code	120

Prefaces

Revision

Revision	Description	Date
1.0	Manual Released	2016/08/23
1.1	Switches and Connectors Revised	2017/09/12
1.2	Power Connector Definition Revised	2017/11/02
1.3	Upper Cover 2D Drawing Revised	2017/11/29
1.4	GPIO Sample Code Revised	2018/02/09
1.5	New-added CPU support and OS revision	2018/08/20
1.6	WDT & GPIO Sample Code Revised	2018/11/27
1.7	New-added TPM support	2019/02/11
1.8	New-added RST (UEFI RAID) configuration and TPM 2.0 support	2020/03/12

Disclaimer

All specifications and information in this User's Manual are believed to be accurate and up to date. C&T Solution Inc. does not guarantee that the contents herein are complete, true, accurate or non-misleading. The information in this document is subject to change without notice and does not represent a commitment on the part of C&T Solution Inc.

C&T Solution Inc. disclaims all warranties, express or implied, including, without limitation, those of merchantability, fitness for a particular purpose with respect to contents of this User's Manual. Users must take full responsibility for the application of the product.

Copyright Notice

All rights reserved. No part of this manual may be reproduced or transmitted in any form or by any means, electronic or mechanical, including photocopying, recording, or information storage and retrieval systems, without the prior written permission of C&T Solution Inc. Copyright © C&T Solution Inc.

Trademarks Acknowledgment

Intel®, Celeron® and Pentium® are trademarks of Intel Corporation.

Windows® is registered trademark of Microsoft Corporation.

AMI is trademark of American Megatrend Inc.

IBM, XT, AT, PS/2 and Personal System/2 are trademarks of International Business Machines Corporation

All other products and trademarks mentioned in this manual are trademarks of their respective owners.

Environmental Protection Announcement

Do not dispose this electronic device into the trash while discarding. Please recycle to minimize pollution and ensure environment protection.

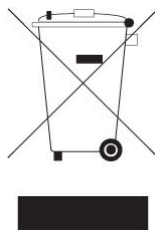

Safety Precautions

Before installing and using the equipment, please read the following precautions:

- Put this equipment on a reliable surface during installation. Dropping it or letting it fall could cause damage.
- The power outlet shall be installed near the equipment and shall be easily accessible.
- Turn off the system power and disconnect the power cord from its source before making any installation. Be sure both the system and the external devices are turned OFF. Sudden surge
- of power could ruin sensitive components. Make sure the equipment is properly grounded.
- When the power is connected, never open the equipment. The equipment should be opened only by qualified service personnel.
- Make sure the voltage of the power source is correct before connecting the equipment to the power outlet.
- Disconnect this equipment from the power before cleaning. Use a damp cloth. Do not use liquid or spray detergents for cleaning.
- Avoid the dusty, humidity and temperature extremes.
- Do not place heavy objects on the equipment.
- If the equipment is not used for long time, disconnect it from the power to avoid being damaged by transient over-voltage.
- The storage temperature shall be above -30°C and below 85°C .
- The computer is provided with a battery-powered real-time clock circuit. There is a danger of explosion if incorrectly replaced. Replace only with the same or equivalent type recommended by the manufacturer.
- If one of the following situation arises, get the equipment checked by service personnel:
 - The power cord or plug is damaged.
 - Liquid has penetrated into the equipment.
 - The equipment has been exposed to moisture.
 - The equipment does not work well or it cannot work according the user's manual.
 - The equipment has been dropped and damaged.
 - The equipment has obvious signs of breakage.

Technical Support and Assistance

1. Visit the C&T Solution Inc website at www.candtsolution.com where you can find the latest information about the product.
2. Contact your distributor, our technical support team or sales representative for technical support if you need additional assistance. Please have following information ready before you call:
 - Model name and serial number
 - Description of your peripheral attachments
 - Description of your software (operating system, version, application software, etc.)
 - A complete description of the problem
 - The exact wording of any error messages

Conventions Used in this Manual

**WARNING**

This indication alerts operators to an operation that, if not strictly observed, may result in severe injury.

**CAUTION**

This indication alerts operators to an operation that, if not strictly observed, may result in safety hazards to personnel or damage to equipment.

**NOTE**

This indication provides additional information to complete a task easily.

Package Contents

Before installation, please ensure all the items listed in the following table are included in the package.

Item	Description	Q'ty
1	RCO-6000 Series Fanless Embedded System	1
2	Utility DVD Driver	1
3	Wall Mount Kit	1
4	Accessory Kit	1
5	DVI to VGA Adapter	1

Ordering Information

Model No.	Product Description
RCO-6000	Superior fanless embedded system with LGA 1151 for Intel® 6 th /7 th Gen Processor and Q170 PCH, 2x LAN
RCO-6000-4L	Superior fanless embedded system with LGA 1151 for Intel® 6 th /7 th Gen Processor and Q170 PCH, 6x LAN
RCO-6000-4L-M12	Superior fanless embedded system with LGA 1151 for Intel® 6 th /7 th Gen Processor and Q170 PCH, 2x LAN, 4x M12 LAN
RCO-6000-8L	Superior fanless embedded system with LGA 1151 for Intel® 6 th /7 th Gen Processor and Q170 PCH, 10x LAN
RCO-6000-8L-M12	Superior fanless embedded system with LGA 1151 for Intel® 6 th /7 th Gen Processor and Q170 PCH, 2x LAN, 8x M12 LAN
RCO-6000-4P	Superior fanless embedded system with LGA 1151 for Intel® 6 th /7 th Gen Processor and Q170 PCH, 2x LAN, 4x PoE
RCO-6000-4P-M12	Superior fanless embedded system with LGA 1151 for Intel® 6 th /7 th Gen Processor and Q170 PCH, 2x LAN, 4x M12 PoE
RCO-6000-8P	Superior fanless embedded system with LGA 1151 for Intel® 6 th /7 th Gen Processor and Q170 PCH, 2x LAN, 8x PoE
RCO-6000-8P-M12	Superior fanless embedded system with LGA 1151 for Intel® 6 th /7 th Gen Processor and Q170 PCH, 2x LAN, 8x M12 PoE
RCO-6011E	Superior fanless embedded system with LGA 1151 for Intel® 6 th /7 th Gen Processor and Q170 PCH, 2x LAN, 1x PCIe x16 Expansion
RCO-6011E-4L	Superior fanless embedded system with LGA 1151 for Intel® 6 th /7 th Gen Processor and Q170 PCH, 6x LAN, 1x PCIe x16 Expansion
RCO-6011E-4L-M12	Superior fanless embedded system with LGA 1151 for Intel® 6 th /7 th Gen Processor and Q170 PCH, 2x LAN, 4x M12 LAN, 1x PCIe x16 expansion
RCO-6011E-8L	Superior fanless embedded system with LGA 1151 for Intel® 6 th /7 th Gen Processor and Q170 PCH, 10x LAN, 1x PCIe x16 Expansion
RCO-6011E-8L-M12	Superior fanless embedded system with LGA 1151 for Intel® 6 th /7 th Gen Processor and Q170 PCH, 2x LAN, 8x M12 LAN, 1x PCIe x16 Expansion

Model No.	Product Description
RCO-6011E-4P	Superior fanless embedded system with LGA 1151 for Intel® 6 th /7 th Gen Processor and Q170 PCH, 2x LAN, 4x PoE, 1x PCIe x16 Expansion
RCO-6011E-4P-M12	Superior fanless embedded system with LGA 1151 for Intel® 6 th /7 th Gen Processor and Q170 PCH, 2x LAN, 4x M12 PoE, 1x PCIe x16 Expansion
RCO-6011E-8P	Superior fanless embedded system with LGA 1151 for Intel® 6 th /7 th Gen Processor and Q170 PCH, 2x LAN, 8x PoE, 1x PCIe x16 Expansion
RCO-6011E-8P-M12	Superior fanless embedded system with LGA 1151 for Intel® 6 th /7 th Gen Processor and Q170 PCH, 2x LAN, 8x M12 PoE, 1x PCIe x16 Expansion
RCO-6011P	Superior fanless embedded system with LGA 1151 for Intel® 6 th /7 th Gen Processor and Q170 PCH, 2x LAN, 1x PCI Expansion
RCO-6011P-4L	Superior fanless embedded system with LGA 1151 for Intel® 6 th /7 th Gen Processor and Q170 PCH, 6x LAN, 1x PCI Expansion
RCO-6011P-4L-M12	Superior fanless embedded system with LGA 1151 for Intel® 6 th /7 th Gen Processor and Q170 PCH, 2x LAN, 4x M12 LAN, 1x PCI Expansion
RCO-6011P-8L	Superior fanless embedded system with LGA 1151 for Intel® 6 th /7 th Gen Processor and Q170 PCH, 10x LAN, 1x PCI Expansion
RCO-6011P-8L-M12	Superior fanless embedded system with LGA 1151 for Intel® 6 th /7 th Gen Processor and Q170 PCH, 2x LAN, 8x M12 LAN, 1x PCI Expansion
RCO-6011P-4P	Superior fanless embedded system with LGA 1151 for Intel® 6 th /7 th Gen Processor and Q170 PCH, 2x LAN, 4x PoE, 1x PCI Expansion
RCO-6011P-4P-M12	Superior fanless embedded system with LGA 1151 for Intel® 6 th /7 th Gen Processor and Q170 PCH, 2x LAN, 4x M12 PoE, 1x PCI Expansion
RCO-6011P-8P	Superior fanless embedded system with LGA 1151 for Intel® 6 th /7 th Gen Processor and Q170 PCH, 2x LAN, 8x PoE, 1x PCI Expansion
RCO-6011P-8P-M12	Superior fanless embedded system with LGA 1151 for Intel® 6 th /7 th Gen Processor and Q170 PCH, 2x LAN, 8x M12 PoE, 1x PCI Expansion
RCO-6022EE	Superior fanless embedded system with LGA 1151 for Intel® 6 th /7 th Gen Processor and Q170 PCH, 2x LAN, 2x PCIe x8 Expansion
RCO-6022EE-4L	Superior fanless embedded system with LGA 1151 for Intel® 6 th /7 th Gen Processor and Q170 PCH, 6x LAN, 2x PCIe x8 Expansion
RCO-6022EE-4L-M12	Superior fanless embedded system with LGA 1151 for Intel® 6 th /7 th Gen Processor and Q170 PCH, 2x LAN, 4x M12 LAN, 2x PCIe x8 Expansion
RCO-6022EE-8L	Superior fanless embedded system with LGA 1151 for Intel® 6 th /7 th Gen Processor and Q170 PCH, 10x LAN, 2x PCIe x8 Expansion
RCO-6022EE-8L-M12	Superior fanless embedded system with LGA 1151 for Intel® 6 th /7 th Gen Processor and Q170 PCH, 2x LAN, 8x M12 LAN, 2x PCIe x8 Expansion
RCO-6022EE-4P	Superior fanless embedded system with LGA 1151 for Intel® 6 th /7 th Gen Processor and Q170 PCH, 2x LAN, 4x PoE, 2x PCIe x8 Expansion
RCO-6022EE-4P-M12	Superior fanless embedded system with LGA 1151 for Intel® 6 th /7 th Gen Processor and Q170 PCH, 2x LAN, 4x M12 PoE, 2x PCIe x8 Expansion
RCO-6022EE-8P	Superior fanless embedded system with LGA 1151 for Intel® 6 th /7 th Gen Processor and Q170 PCH, 2x LAN, 8x PoE, 2x PCIe x8 Expansion
RCO-6022EE-8P-M12	Superior fanless embedded system with LGA 1151 for Intel® 6 th /7 th Gen Processor and Q170 PCH, 2x LAN, 8x M12 PoE, 2x PCIe x8 Expansion
RCO-6022PP	Superior fanless embedded system with LGA 1151 for Intel® 6 th /7 th Gen Processor and Q170 PCH, 2x LAN, 2x PCI Expansion
RCO-6022PP-4L	Superior fanless embedded system with LGA 1151 for Intel® 6 th /7 th Gen Processor and Q170 PCH, 6x LAN, 2x PCI Expansion
RCO-6022PP-4L-M12	Superior fanless embedded system with LGA 1151 for Intel® 6 th /7 th Gen Processor and Q170 PCH, 2x LAN, 4x M12 LAN, 2x PCI Expansion

Model No.	Product Description
RCO-6022PP-8L	Superior fanless embedded system with LGA 1151 for Intel® 6 th /7 th Gen Processor and Q170 PCH, 10x LAN, 2x PCI Expansion
RCO-6022PP-8L-M12	Superior fanless embedded system with LGA 1151 for Intel® 6 th /7 th Gen Processor and Q170 PCH, 2x LAN, 8x M12 LAN, 2x PCI Expansion
RCO-6022PP-4P	Superior fanless embedded system with LGA 1151 for Intel® 6 th /7 th Gen Processor and Q170 PCH, 2x LAN, 4x PoE, 2x PCI Expansion
RCO-6022PP-4P-M12	Superior fanless embedded system with LGA 1151 for Intel® 6 th /7 th Gen Processor and Q170 PCH, 2x LAN, 4x M12 PoE, 2x PCI Expansion
RCO-6022PP-8P	Superior fanless embedded system with LGA 1151 for Intel® 6 th /7 th Gen Processor and Q170 PCH, 2x LAN, 8x PoE, 2x PCI Expansion
RCO-6022PP-8P-M12	Superior fanless embedded system with LGA 1151 for Intel® 6 th /7 th Gen Processor and Q170 PCH, 2x LAN, 8x M12 PoE, 2x PCI Expansion
RCO-6022PE	Superior fanless embedded system with LGA 1151 for Intel® 6 th /7 th Gen Processor and Q170 PCH, 2x LAN, 1x PCIe x16, 1x PCI Expansion
RCO-6022PE-4L	Superior fanless embedded system with LGA 1151 for Intel® 6 th /7 th Gen Processor and Q170 PCH, 6x LAN, 1x PCIe x16, 1x PCI Expansion
RCO-6022PE-4L-M12	Superior fanless embedded system with LGA 1151 for Intel® 6 th /7 th Gen Processor and Q170 PCH, 2x LAN, 4x M12 LAN, 1x PCIe x16, 1x PCI Expansion
RCO-6022PE-8L	Superior fanless embedded system with LGA 1151 for Intel® 6 th /7 th Gen Processor and Q170 PCH, 10x LAN, 1x PCIe x16, 1x PCI Expansion
RCO-6022PE-8L-M12	Superior fanless embedded system with LGA 1151 for Intel® 6 th /7 th Gen Processor and Q170 PCH, 2x LAN, 8x M12 LAN, 1x PCIe x16, 1x PCI Expansion
RCO-6022PE-4P	Superior fanless embedded system with LGA 1151 for Intel® 6 th /7 th Gen Processor and Q170 PCH, 2x LAN, 4x PoE, 1x PCIe x16, 1x PCI Expansion
RCO-6022PE-4P-M12	Superior fanless embedded system with LGA 1151 for Intel® 6 th /7 th Gen Processor and Q170 PCH, 2x LAN, 4x M12 PoE, 1x PCIe x16, 1x PCI Expansion
RCO-6022PE-8P	Superior fanless embedded system with LGA 1151 for Intel® 6 th /7 th Gen Processor and Q170 PCH, 2x LAN, 8x PoE, 1x PCIe x16, 1x PCI Expansion
RCO-6022PE-8P-M12	Superior fanless embedded system with LGA 1151 for Intel® 6 th /7 th Gen Processor and Q170 PCH, 2x LAN, 8x M12 PoE, 1x PCIe x16, 1x PCI Expansion

Optional Accessories

Model No.	Product Description
1-E09A12002	Adapter AC/DC 24V 5A 120W with 3pin Terminal Block Plug 5.0mm Pitch, GST120A24-CT1
1-E09A22102	Adapter AC/DC 24V 9.2A 220W with 3pin Terminal Block Plug 5.0mm Pitch, GST220A24-CT1
SFICBL022	Power Cord, 3-pin US Type, 180cm
1-TPCD00002	Power Cord, European Type, 180cm
1-TPCD00001	Power Cord, 3-pin UK Type, 180cm
1-TZZZ00001	DVI-I(M) TO DVI-D(F) + VGA(F) Cable, L=120mm, C129P012H1211

Chapter 1

Product Introductions

1.1 Overview

Based on 7th Gen. Intel® Core™ i7-7700T (3.8GHz, Quad Core) / i5-7500T (3.3GHz, Quad Core) / i3-7101TE (3.4GHz, Dual Core) or 6th Gen. Intel® Core™ i7-6700TE (3.4GHz, Quad Core) / i5-6500TE (3.3GHz, Quad Core) / i3-6100TE (2.7GHz, Dual Core) or Pentium® G4400TE (2.4GHz, Dual Core) / Celeron® G3900TE (2.3GHz, Dual Core) Desktop processor, RCO-6000 series is an extreme features integration, outstanding system performance, versatile I/O connections, and rugged reliability fanless embedded systems. It offers dramatically enhanced CPU and graphics performance, wide power and feature scalability, and advanced features, modularize expansion I/O, rich connectivity interfaces, wide range (9~48V) DC power input, and high reliability even operating in temperature extremes (-25 °C~+70 °C).

Featuring with completely cable-less designed, high functional, one-piece housing design, and anti-vibration, RCO-6000 series are ruggedized systems that can operate in harsh environments and easy to install and maintain. A build in over voltage protection (OVP), over current protection (OCP), reverse protection, and wide range DC power input makes RCO-6000 series are safety system for all industrial applications.

RCO-6000 Series

RCO-6011 Series

RCO-6022 Series



1.1.1 Key Features

- LGA 1151 socket for 6th/7th Gen. Intel® Core™ i7/i5/i3 or Pentium® / Celeron® Desktop Processor
- Intel® Q170 Chipset
- 2x 260-pin DDR4 SODIMM. Max up to 32GB
- Triple independent display supported by 1x DVI-I and 2x DisplayPort
- 2x Intel® GbE supporting Wake-on-LAN and PXE
- 2x Removable 2.5" SATA HDD Bay, 2x Internal 2.5" SATA SSD/HDD Bay supporting RAID 0, 1, 5, 10
- 4x Full-size Mini-PCIe Socket with 4x SIM Card Socket for communication or expansion modules
- 2x mSATA (Shared by 2x Mini-PCIe Socket)
- 2x External RS-232/422/485, 2x Internal RS-232/422/485
- 6x USB 3.0, 2x USB 2.0, TPM 2.0
- 8x Isolated DI, 8x Isolated DO
- 1x Mic-in, 1x Speak-out
- 9 to 48VDC wide range power input supporting AT/ATX mode
- 1x PCIe x16 Expansion (RCO-6011E Series Only)
- 1x PCI Expansion (RCO-6011P Series Only)
- 2x PCIe x8 Expansion (RCO-6022EE Series Only)
- 2x PCI Expansion (RCO-6022PP Series Only)
- 1x PCIe x16 and 1x PCI Expansion (RCO-6022PE Series Only)
- Remote Power On/Off Switch

1.2 Hardware Specification

Processor System

- Support 6th & 7th Gen Intel® Core™ i7 / i5 / i3 / Pentium® / Celeron® Desktop Processor (LGA 1151) with AMI 128Mbit SPI BIOS
 - 7th Gen Intel® Core™ i7-7700T, Quad Core, 8MB cache, up to 3.8 GHz
 - 7th Gen Intel® Core™ i5-7500T, Quad Core, 6MB cache, up to 3.3 GHz
 - 7th Gen Intel® Core™ i3-7101TE, Dual Core, 3MB Cache, 3.4 GHz
 - 6th Gen Intel® Core™ i7-6700TE, Quad Core, 8MB cache, up to 3.4 GHz
 - 6th Gen Intel® Core™ i5-6500TE, Quad Core, 6MB Cache, up to 3.3 GHz
 - 6th Gen Intel® Core™ i3-6100TE, Dual Core, 4MB Cache, 2.7 GHz
 - Intel® Pentium G4400TE, Dual Core, 3MB Cache, 2.4 GHz
 - Intel® Celeron G3900TE, Dual Core, 2MB Cache, 2.3 GHz

Memory

- 2x 260-Pin DDR4 1866/2133MHz SODIMM. Max. up to 32GB

Display

Triple Display

- 1x DVI-I, 1x VGA, and 2x DisplayPort

Expansion

- 4x Full-size Mini PCIe Socket for Wi-Fi / GSM / Expansion Module
- 1x PCIe x16 expansion (RCO-6011E series only)
- 1x PCI expansion (RCO-6011P series only)
- 2x PCIe x8 expansion (RCO-6022EE series only)
- 2x PCI expansion (RCO-6022PP series only)
- 1x PCIe x16 and 1x PCI expansion (RCO-6022PE series only)
- Card Dimension: 235 (L) x 112 (H) mm

Ethernet

- 1x Intel® i210-AT GbE LAN Port and 1x Intel® i219LM GbE LAN , Support Wake-on-LAN and PXE
- 4x Intel® I210-AT GbE LAN Port
[RCO-60xx-4L and RCO-60xx-4L-M12only]
- 8x Intel® I210-AT GbE LAN Port
[RCO-60xx-8L and RCO-60xx-8L-M12only]
- 4x 802.3at Compliant PoE Port, The Maximum DC Power Delivery on Each PoE is 25.5W
[RCO-60xx-4P and RCO-60xx-4P-M12only]
- 8x 802.3at Compliant PoE Port, The Maximum DC Power Delivery on Each PoE is 25.5W. 80W total power budget
[RCO-60xx-8P and RCO-60xx-8P-M12 only]

Audio

- Codec: Realtek ALC888S
- 1x Mic-in and 1x Speak-out

Watchdog Timer

- Software Programmable Supports 1~255 sec.
- System Reset

TPM

- TPM 2.0

Storage

- 2x Removable 2.5" SATA HDD Bay
- 2x Internal 2.5" SATA HDD Bay
- 2x Internal mSATA Slot (Shared by 2x Mini-PCIe Socket)
- 2x External SIM Card Socket
- 2x Internal SIM Card Socket
- Support RAID 0, 1, 5, 10

I/O Ports

- 6x USB 3.0 Port
- 2x USB 2.0 Port
- 8 Isolated DI and 8 Isolated DO Port
- 2x DB9 for COM1~2, Support RS232/422/485 with Auto Flow Control
- 2x Internal connector for COM3~4, Support RS232/422/485 with Auto Flow Control
- 6x Antenna Hole
- 1x Power Switch
- 1x AT/ATX Switch
- 1x Remote Power on/off Connector

Digital Input & Output

- 8x Digital Input (Source Type)
 - Input Voltage (Dry Contact):
 - Logic 0: Close to GND
 - Logic 1: Open
 - Input Voltage:
 - Logic 0: 3V max.
 - Logic 1: 5V min. (DI to COM-)
- 8x Digital Output
 - Supply Voltage: 5~30VDC
 - Sink Current: 200 mA Max. Per Channel

Power

- Support AT, ATX Mode
- 1x 3-pin Terminal Block Connector with Power Input 9~48VDC
- 1x Optional AC/DC 24V/5A, 120W Power Adapter

Environment

- Operating Temperature: Ambient with Air Flow: -25°C to 70°C (with Industrial Grade Peripherals)
- Storage Temperature: -30°C to 85°C
- Relative humidity: 10%~95% (non-condensing)

Physical

- **RCO-6000 Series**
 - ✓ Dimension (WxDxH): 240 x 261 x 79 mm
 - ✓ Weight: 4.37 kg ~ 5.41 kg
- **RCO-6011 Series**
 - ✓ Dimension (WxDxH): 240 x 261 x 107 mm
 - ✓ Weight: TBC
- **RCO-6022 Series**
 - ✓ Dimension (WxDxH): 240 x 261 x 127 mm
 - ✓ Weight: 5.54 kg ~ 6.64 kg
- Construction: Extruded Aluminum with Heavy Duty Metal
- Mounting: Wall Mounting

Operating System

- 6th Gen CPU: Windows 10, Windows 7, WES7
- 7th Gen CPU: Windows 10
- Linux kernel 4.X

Certifications

- CE
- FCC Class A

1.3 System I/O

1.3.1 RCO-6000

Front Panel

ATX power on/off switch

Press to power-on or power-off the system

Reset switch

Press to reset the system

USB 3.0 port

Used to connect USB 3.0/2.0/1.1 device

USB 2.0 port

Used to connect USB 2.0/1.1 device

AT/ATX mode select switch

Used to select AT or ATX power mode

Clear CMOS

Used to clear CMOS

SIM card

Used to insert SIM card

COM port

COM1 ~ COM2 support RS232/422/485 serial device

Universal I/O Bracket

Used to customized I/O output

HDD port

Removable 2.5" SATA HDD Area

Power LED

Indicates the power status of the system

HDD LED

Indicates the status of the hard drive

Watchdog LED

Indicates the status of the watchdog active

GPIO LED

Indicates the status of the customer define

Ethernet LEDs

Indicates the status of the LAN active

Antenna hole

Used to connect an antenna for optional Mini-PCIe WiFi module

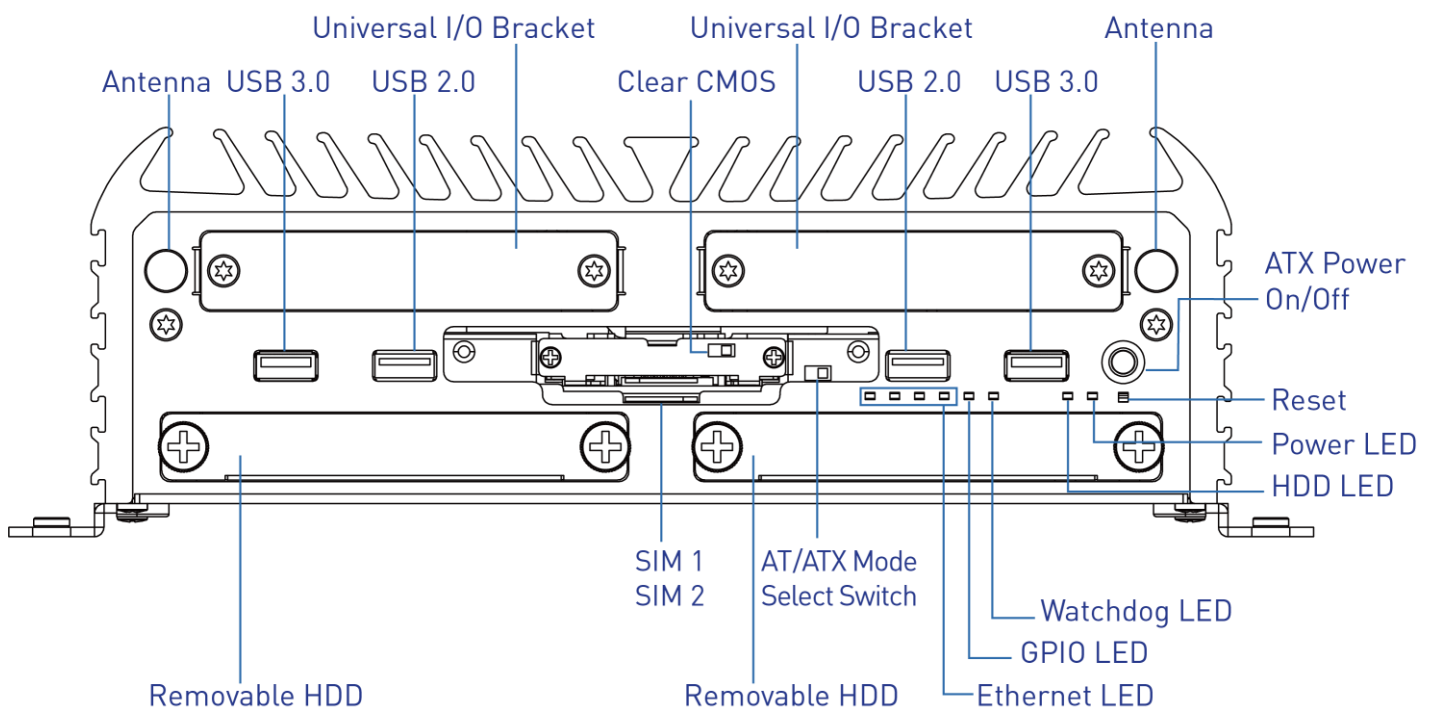

Rear Panel

DC IN

Used to plug a DC power input with terminal block

Speaker-out

Used to connect a speaker

Mic-in

Used to connect a microphone

Digital I/O Terminal Block

The Digital I/O terminal block supports 8 digital input and 8 digital output

COM port

COM1 ~ COM2 support RS232/422/485 serial device

DVI-I port

Used to connect a DVI monitor or connect optional split cable for dual display mode

DisplayPort

Used to connect a DisplayPort monitor

USB 3.0 port

Used to connect USB 3.0/2.0/1.1 device

LAN port

Used to connect the system to a local area network

Remote Power on/off Terminal Block

Used to plug a remote power on/off terminal block

Antenna hole

Used to connect an antenna for optional Mini-PCIe WiFi module

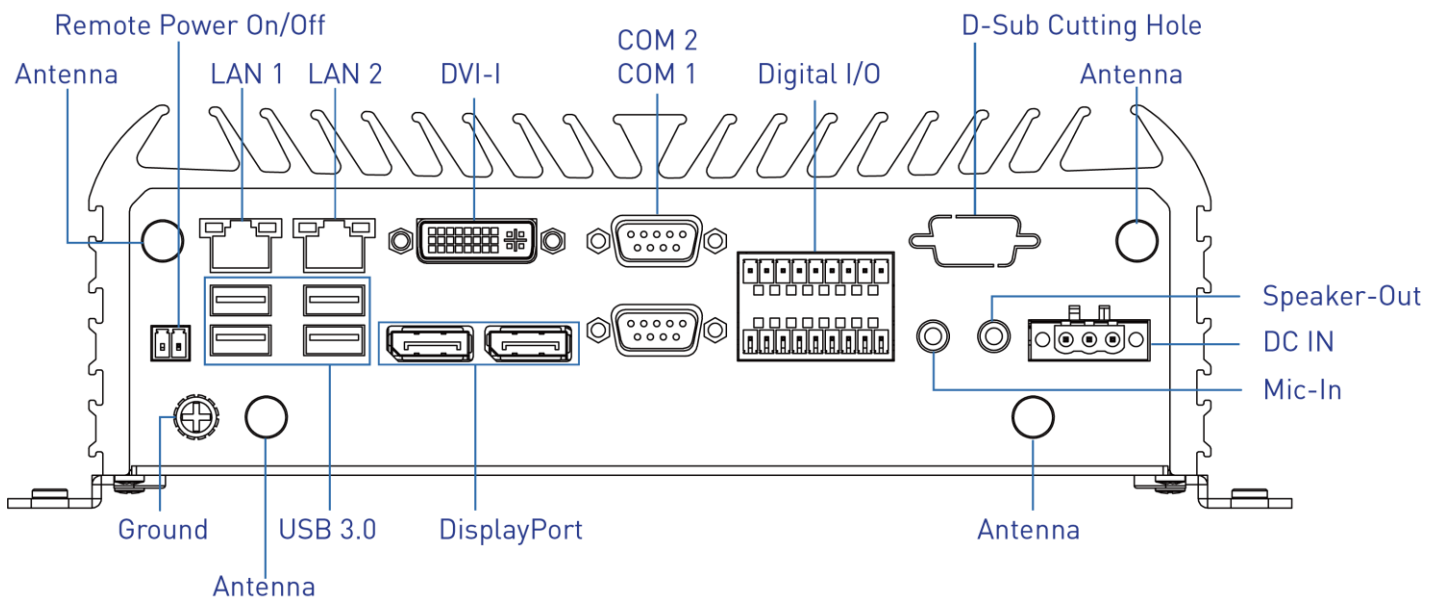

1.3.2 RCO-6000-4L(P)

Front Panel

ATX power on/off switch

Press to power-on or power-off the system

Reset switch

Press to reset the system

USB 3.0 port

Used to connect USB 3.0/2.0/1.1 device

USB 2.0 port

Used to connect USB 2.0/1.1 device

AT/ATX mode select switch

Used to select AT or ATX power mode

Clear CMOS

Used to clear CMOS

SIM card

Used to insert SIM card

COM port

COM1 ~ COM2 support RS232/422/485 serial device

LAN Port

Used to connect the system to a local area network (RCO-6000-4L Only)

PoE Port

Used to connect the system to a local area network with power over Ethernet (RCO-6000-4P Only)

Universal I/O Bracket

Used to customized I/O output

HDD port

Removable 2.5" SATA HDD Area

Power LED

Indicates the power status of the system

HDD LED

Indicates the status of the hard drive

Watchdog LED

Indicates the status of the watchdog active

GPIO LED

Indicates the status of the customer define

Ethernet LEDs

Indicates the status of the LAN active

Antenna hole

Used to connect an antenna for optional Mini-PCIe WiFi module

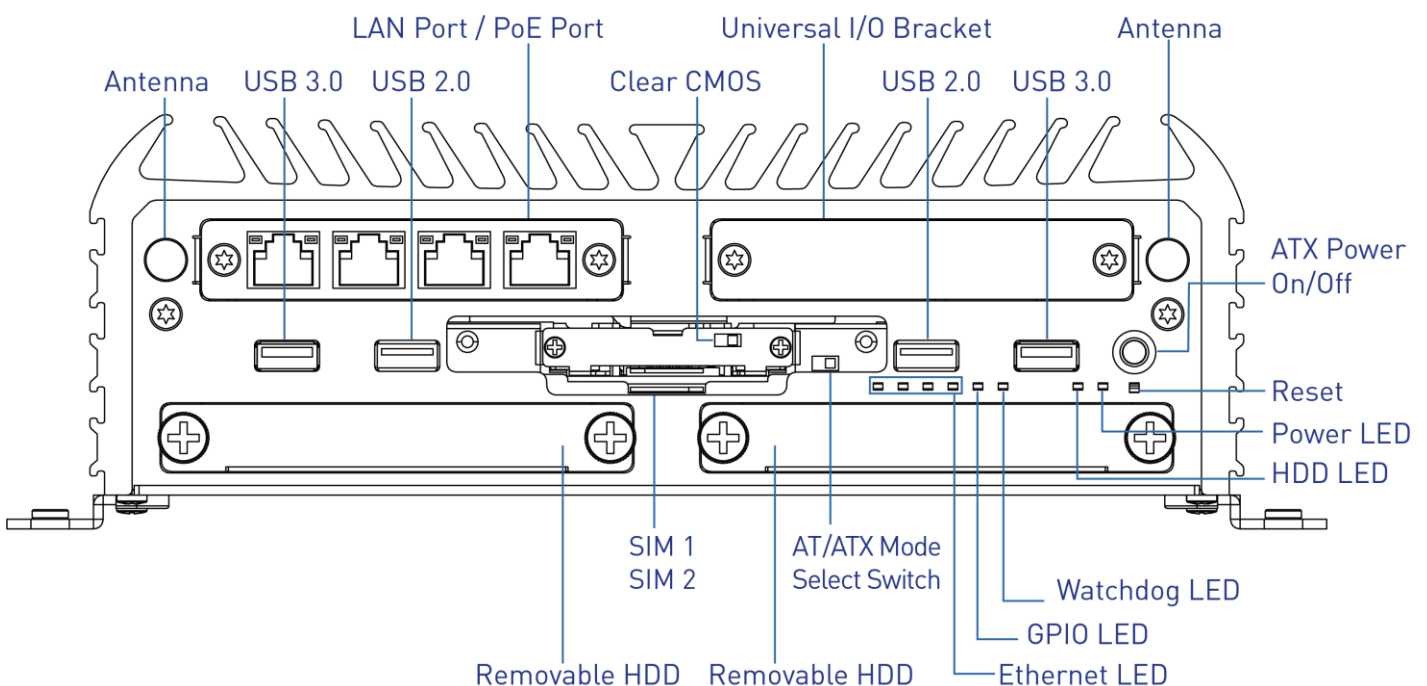

Rear Panel

DC IN

Used to plug a DC power input with terminal block

Speaker-out

Used to connect a speaker

Mic-in

Used to connect a microphone

Digital I/O Terminal Block

The Digital I/O terminal block supports 8 digital input and 8 digital output

COM port

COM1 ~ COM2 support RS232/422/485 serial device

DVI-I port

Used to connect a DVI monitor or connect optional split cable for dual display mode

DisplayPort

Used to connect a DisplayPort monitor

USB 3.0 port

Used to connect USB 3.0/2.0/1.1 device

LAN port

Used to connect the system to a local area network

Remote Power on/off Terminal Block

Used to plug a remote power on/off terminal block

Antenna hole

Used to connect an antenna for optional Mini-PCIe WiFi module

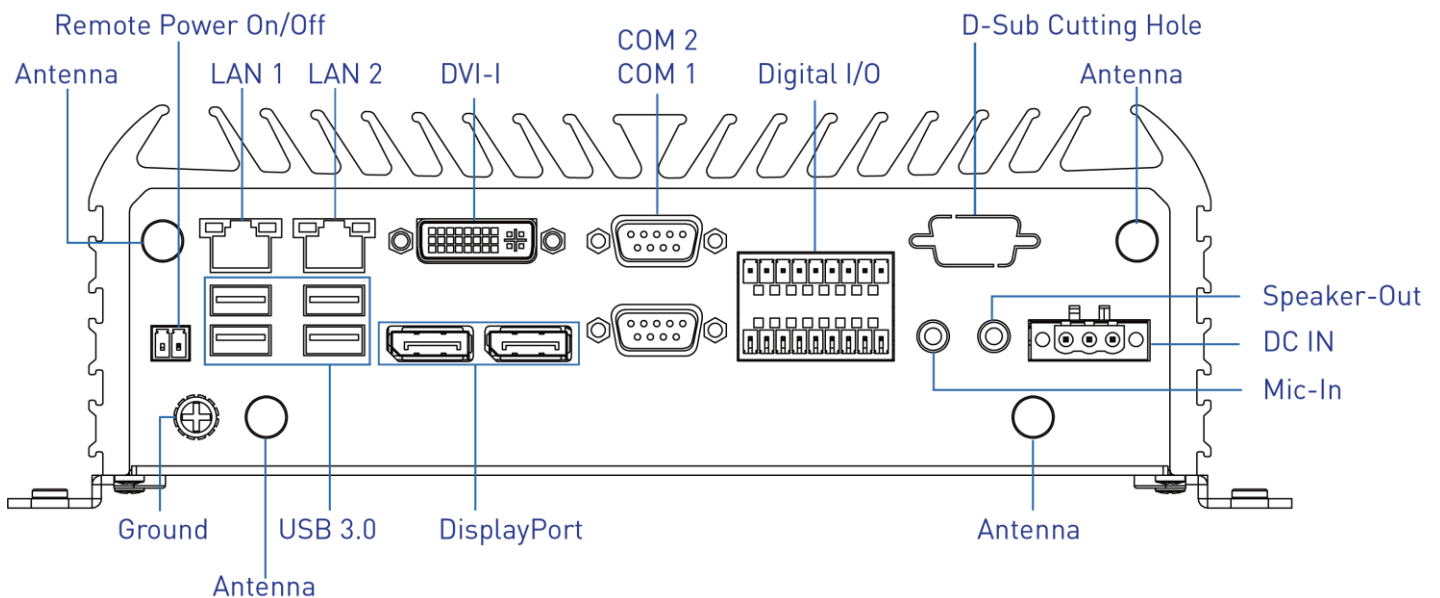

1.3.3 RCO-6000-4L(P)-M12

Front Panel

ATX power on/off switch

Press to power-on or power-off the system

Reset switch

Press to reset the system

USB 3.0 port

Used to connect USB 3.0/2.0/1.1 device

USB 2.0 port

Used to connect USB 2.0/1.1 device

AT/ATX mode select switch

Used to select AT or ATX power mode

Clear CMOS

Used to clear CMOS

SIM card

Used to insert SIM card

COM port

COM1 ~ COM2 support RS232/422/485 serial device

M12 LAN Port

Used to connect the system to a local area network (RCO-6000-4L-M12 Only)

M12 PoE Port

Used to connect the system to a local area network with power over Ethernet (RCO-6000-4P-M12 Only)

Universal I/O Bracket

Used to customized I/O output

HDD port

Removable 2.5" SATA HDD Area

Power LED

Indicates the power status of the system

HDD LED

Indicates the status of the hard drive

Watchdog LED

Indicates the status of the watchdog active

GPIO LED

Indicates the status of the customer define

Ethernet LEDs

Indicates the status of the LAN active

Antenna hole

Used to connect an antenna for optional Mini-PCIe WiFi module

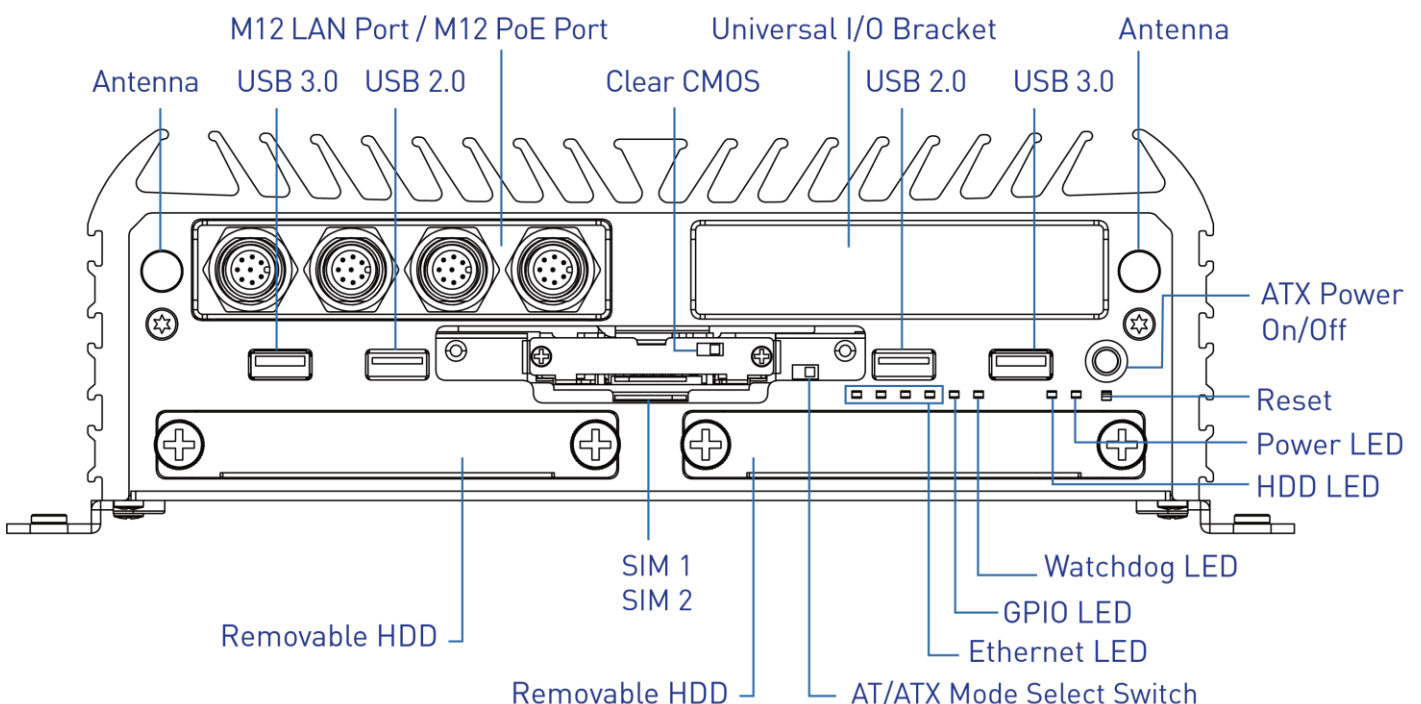

Rear Panel

DC IN

Used to plug a DC power input with terminal block

Speaker-out

Used to connect a speaker

Mic-in

Used to connect a microphone

Digital I/O Terminal Block

The Digital I/O terminal block supports 8 digital input and 8 digital output

COM port

COM1 ~ COM2 support RS232/422/485 serial device

DVI-I port

Used to connect a DVI monitor or connect optional split cable for dual display mode

DisplayPort

Used to connect a DisplayPort monitor

USB 3.0 port

Used to connect USB 3.0/2.0/1.1 device

LAN port

Used to connect the system to a local area network

Remote Power on/off Terminal Block

Used to plug a remote power on/off terminal block

Antenna hole

Used to connect an antenna for optional Mini-PCIe WiFi module

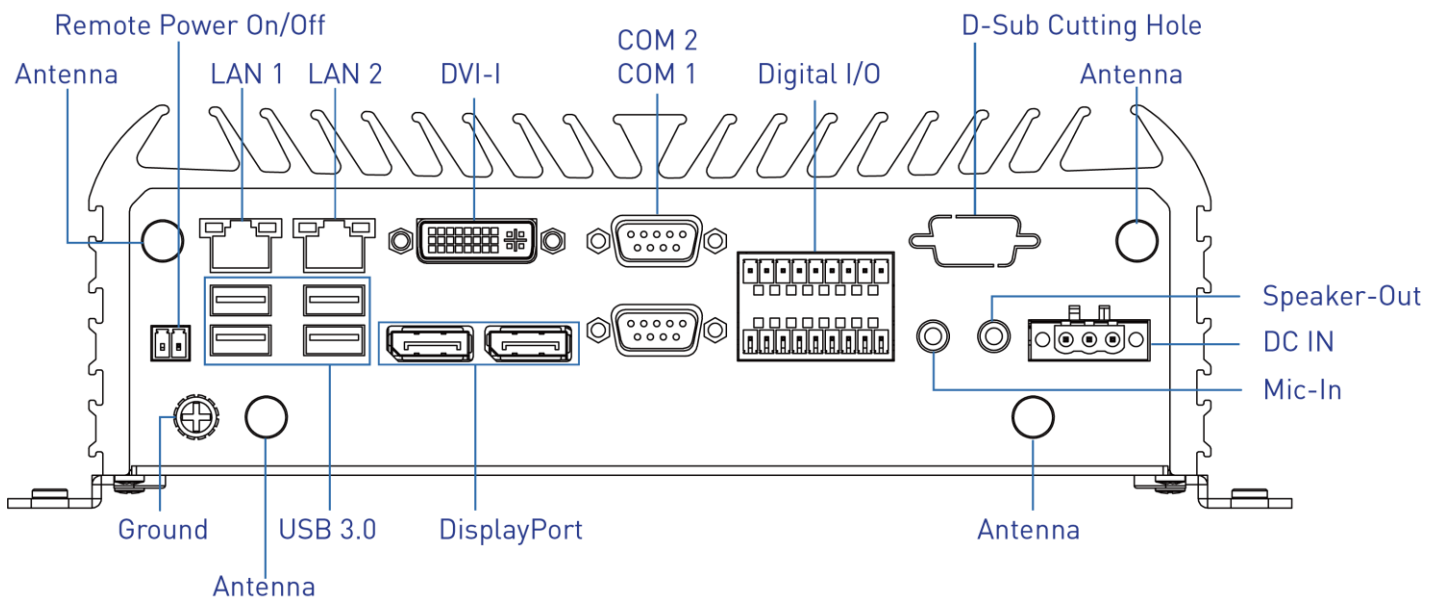

1.3.4 RCO-6000-8L(P)

Front Panel

ATX power on/off switch

Press to power-on or power-off the system

Reset switch

Press to reset the system

USB 3.0 port

Used to connect USB 3.0/2.0/1.1 device

USB 2.0 port

Used to connect USB 2.0/1.1 device

AT/ATX mode select switch

Used to select AT or ATX power mode

Clear CMOS

Used to clear CMOS

SIM card

Used to insert SIM card

COM port

COM1 ~ COM2 support RS232/422/485 serial device

LAN Port

Used to connect the system to a local area network (RCO-6000-8L Only)

PoE Port

Used to connect the system to a local area network with power over Ethernet (RCO-6000-8P Only)

HDD port

Removable 2.5" SATA HDD Area

Power LED

Indicates the power status of the system

HDD LED

Indicates the status of the hard drive

Watchdog LED

Indicates the status of the watchdog active

GPIO LED

Indicates the status of the customer define

Ethernet LEDs

Indicates the status of the LAN active

Antenna hole

Used to connect an antenna for optional Mini-PCIe WiFi module

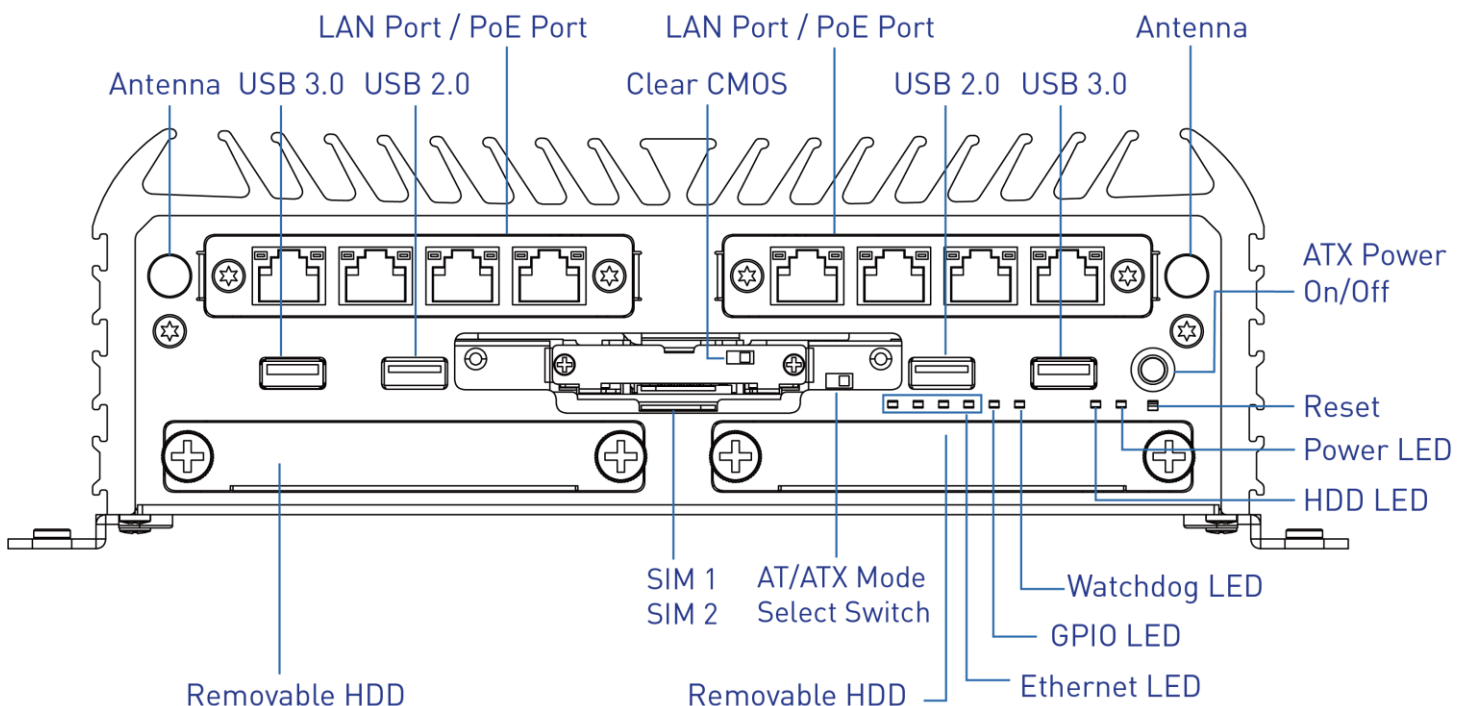

Rear Panel

DC IN

Used to plug a DC power input with terminal block

Speaker-out

Used to connect a speaker

Mic-in

Used to connect a microphone

Digital I/O Terminal Block

The Digital I/O terminal block supports 8 digital input and 8 digital output

COM port

COM1 ~ COM2 support RS232/422/485 serial device

DVI-I port

Used to connect a DVI monitor or connect optional split cable for dual display mode

DisplayPort

Used to connect a DisplayPort monitor

USB 3.0 port

Used to connect USB 3.0/2.0/1.1 device

LAN port

Used to connect the system to a local area network

Remote Power on/off Terminal Block

Used to plug a remote power on/off terminal block

Antenna hole

Used to connect an antenna for optional Mini-PCIe WiFi module

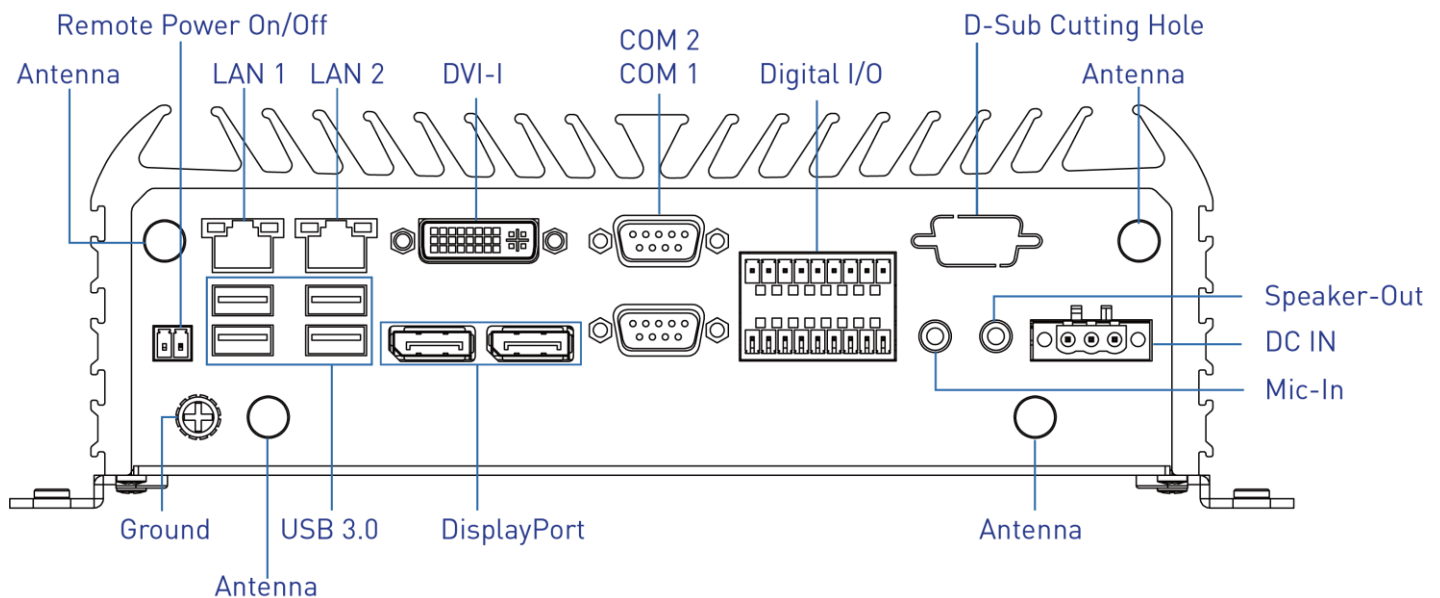

1.3.5 RCO-6000-8L(P)-M12

Front Panel

ATX power on/off switch

Press to power-on or power-off the system

Reset switch

Press to reset the system

USB 3.0 port

Used to connect USB 3.0/2.0/1.1 device

USB 2.0 port

Used to connect USB 2.0/1.1 device

AT/ATX mode select switch

Used to select AT or ATX power mode

Clear CMOS

Used to clear CMOS

SIM card

Used to insert SIM card

COM port

COM1 ~ COM2 support RS232/422/485 serial device

M12 LAN Port

Used to connect the system to a local area network (RCO-6000-8L-M12 Only)

M12 PoE Port

Used to connect the system to a local area network with power over Ethernet (RCO-6000-8P-M12 Only)

HDD port

Removable 2.5" SATA HDD Area

Power LED

Indicates the power status of the system

HDD LED

Indicates the status of the hard drive

Watchdog LED

Indicates the status of the watchdog active

GPIO LED

Indicates the status of the customer define

Ethernet LEDs

Indicates the status of the LAN active

Antenna hole

Used to connect an antenna for optional Mini-PCIe WiFi module

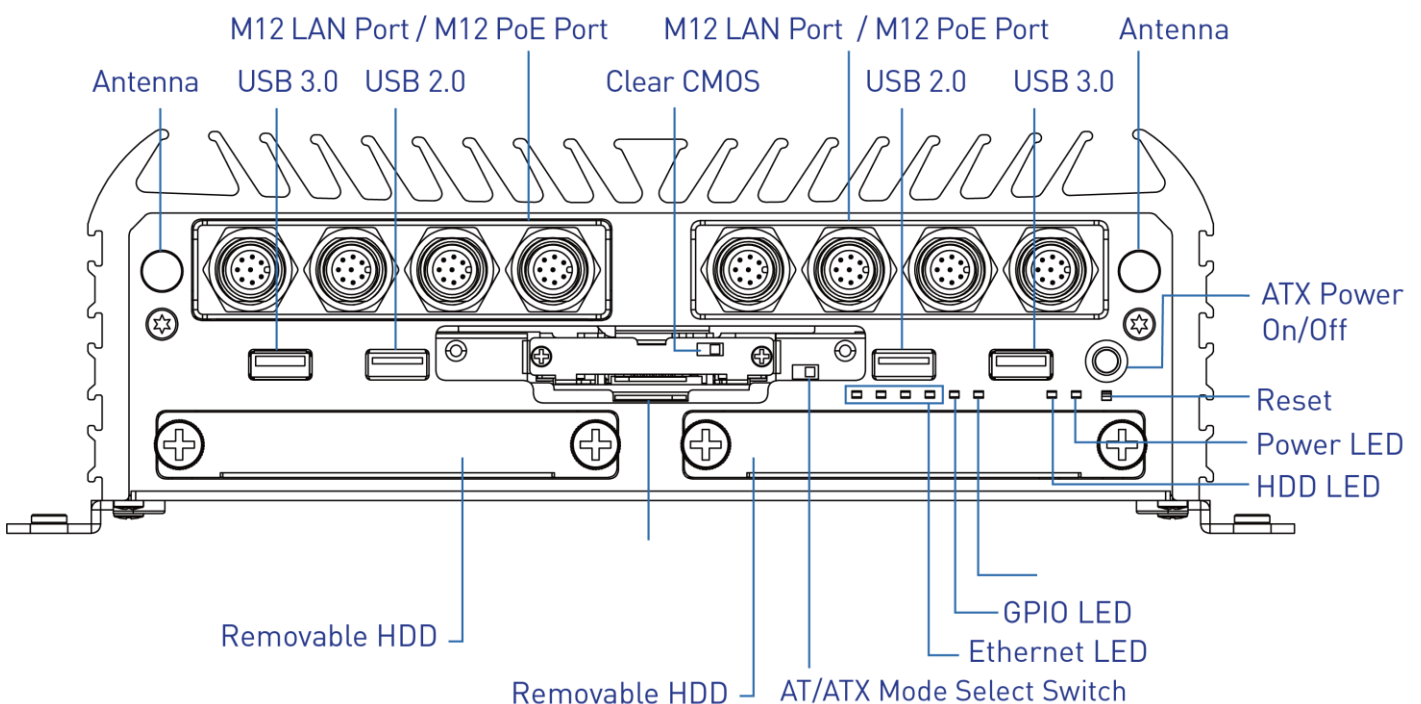

Rear Panel

DC IN

Used to plug a DC power input with terminal block

Speaker-out

Used to connect a speaker

Mic-in

Used to connect a microphone

Digital I/O Terminal Block

The Digital I/O terminal block supports 8 digital input and 8 digital output

COM port

COM1 ~ COM2 support RS232/422/485 serial device

DVI-I port

Used to connect a DVI monitor or connect optional split cable for dual display mode

DisplayPort

Used to connect a DisplayPort monitor

USB 3.0 port

Used to connect USB 3.0/2.0/1.1 device

LAN port

Used to connect the system to a local area network

Remote Power on/off Terminal Block

Used to plug a remote power on/off terminal block

Antenna hole

Used to connect an antenna for optional Mini-PCIe WiFi module

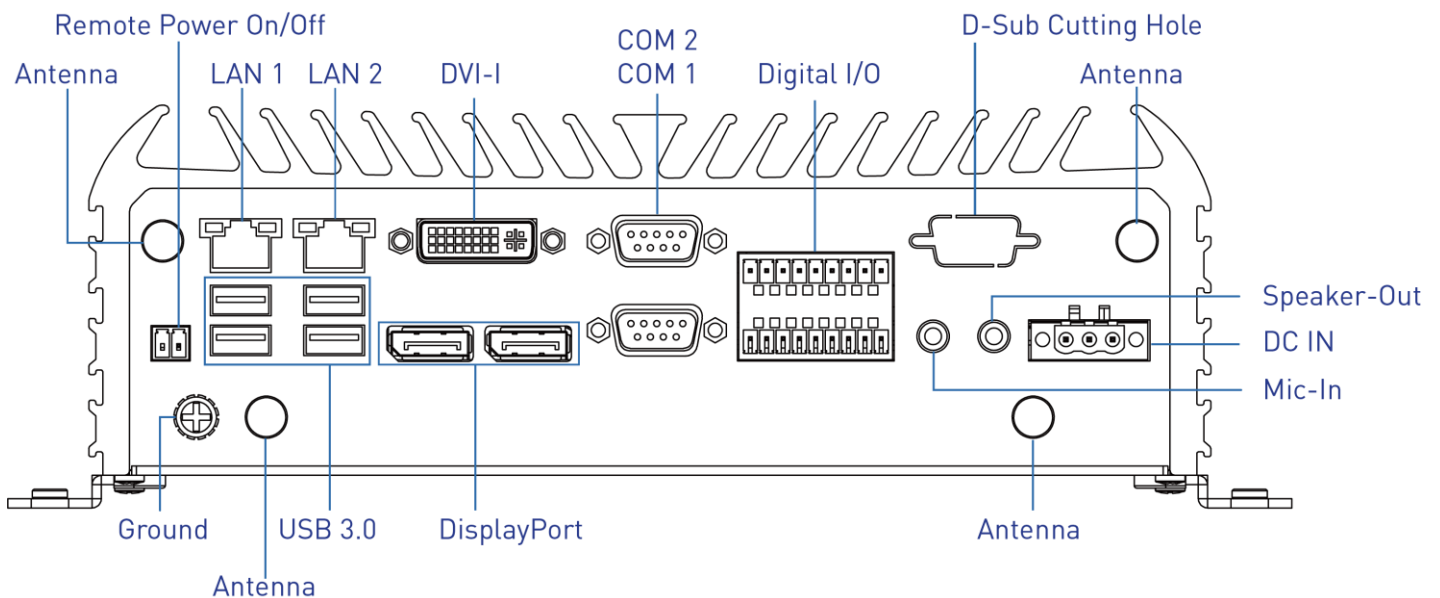

1.3.6 RCO-6011E(P)

Front Panel

ATX power on/off switch

Press to power-on or power-off the system

Reset switch

Press to reset the system

USB 3.0 port

Used to connect USB 3.0/2.0/1.1 device

USB 2.0 port

Used to connect USB 2.0/1.1 device

AT/ATX mode select switch

Used to select AT or ATX power mode

Clear CMOS

Used to clear CMOS

SIM card

Used to insert SIM card

COM port

COM1 ~ COM2 support RS232/422/485 serial device

Universal I/O Bracket

Used to customized I/O output

HDD port

Removable 2.5" SATA HDD Area

Power LED

Indicates the power status of the system

HDD LED

Indicates the status of the hard drive

Watchdog LED

Indicates the status of the watchdog active

GPIO LED

Indicates the status of the customer define

Ethernet LEDs

Indicates the status of the LAN active

Antenna hole

Used to connect an antenna for optional Mini-PCIe WiFi module

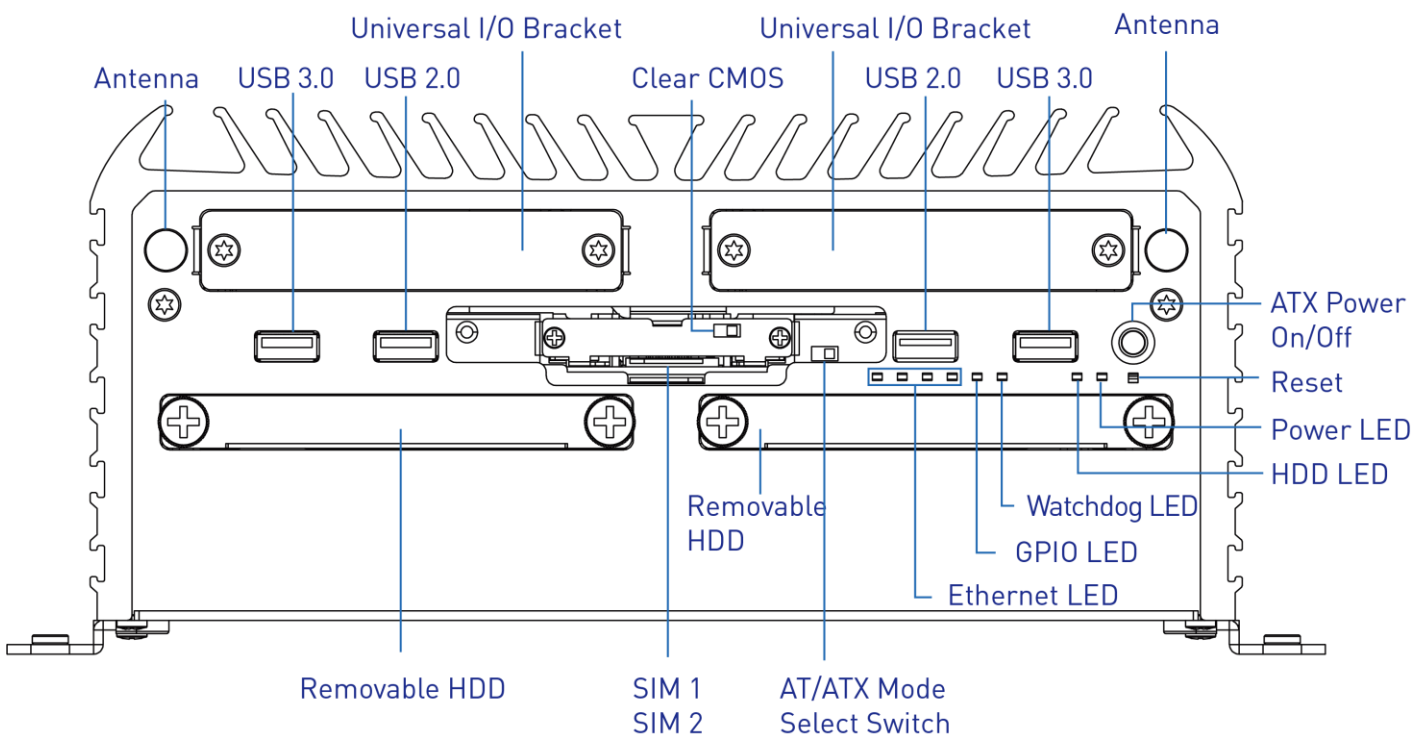

Rear Panel

DC IN

Used to plug a DC power input with terminal block

Speaker-out

Used to connect a speaker

Mic-in

Used to connect a microphone

Digital I/O Terminal Block

The Digital I/O terminal block supports 8 digital input and 8 digital output

COM port

COM1 ~ COM2 support RS232/422/485 serial device

DVI-I port

Used to connect a DVI monitor or connect optional split cable for dual display mode

DisplayPort

Used to connect a DisplayPort monitor

USB 3.0 port

Used to connect USB 3.0/2.0/1.1 device

LAN port

Used to connect the system to a local area network

Remote Power on/off Terminal Block

Used to plug a remote power on/off terminal block

Expansion Area

Used to plug PCIe Card (RCO-6011E Only)

Used to plug PCI Card (RCO-6011P Only)

Antenna hole

Used to connect an antenna for optional Mini-PCIe WiFi module

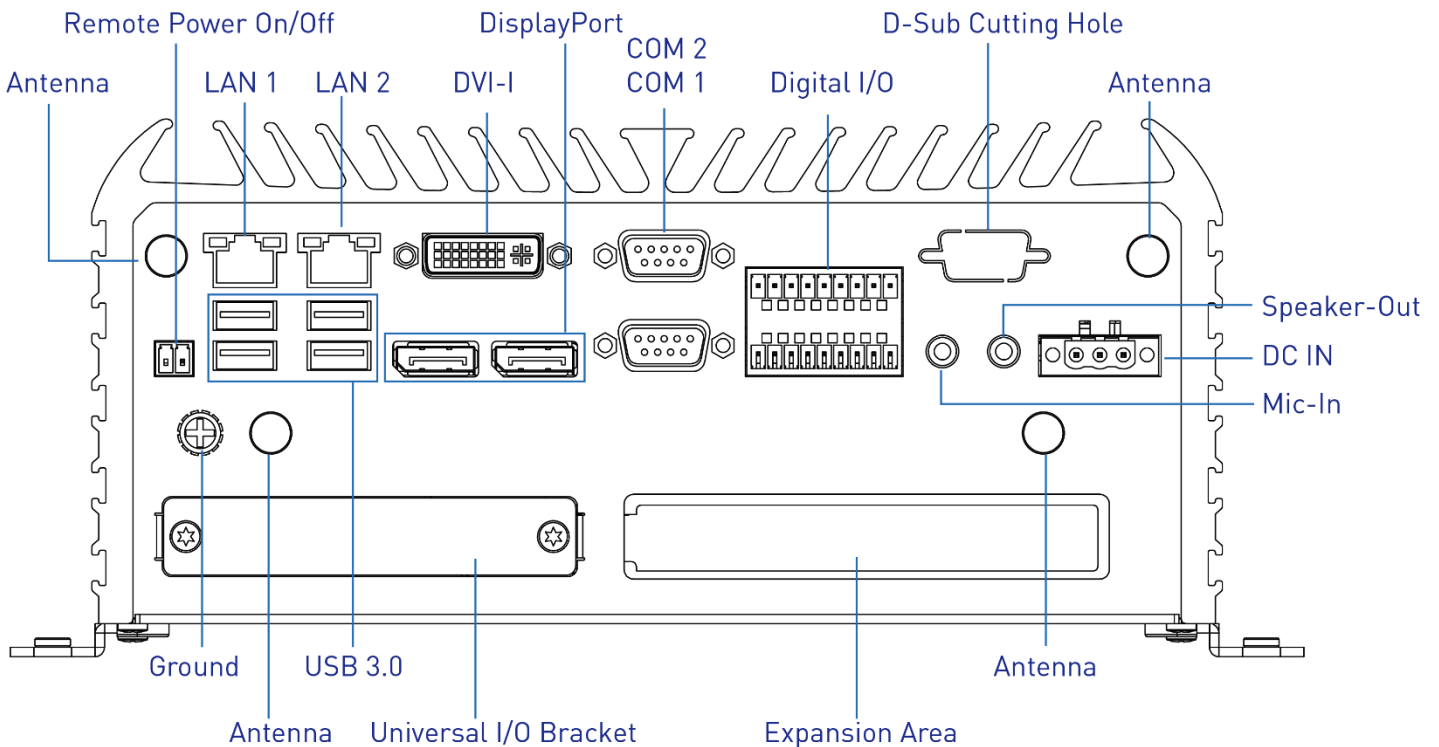

1.3.7 RCO-6011E(P)-4L(P)

Front Panel

ATX power on/off switch

Press to power-on or power-off the system

Reset switch

Press to reset the system

USB 3.0 port

Used to connect USB 3.0/2.0/1.1 device

USB 2.0 port

Used to connect USB 2.0/1.1 device

AT/ATX mode select switch

Used to select AT or ATX power mode

Clear CMOS

Used to clear CMOS

SIM card

Used to insert SIM card

COM port

COM1 ~ COM2 support RS232/422/485 serial device

LAN Port

Used to connect the system to a local area network (RCO-6011E-4L & RCO-6011P-4L Only)

PoE Port

Used to connect the system to a local area network with power over Ethernet (RCO-6011E-4P & RCO-6011P-4P Only)

Universal I/O Bracket

Used to customized I/O output

HDD port

Removable 2.5" SATA HDD Area

Power LED

Indicates the power status of the system

HDD LED

Indicates the status of the hard drive

Watchdog LED

Indicates the status of the watchdog active

GPIO LED

Indicates the status of the customer define

Ethernet LEDs

Indicates the status of the LAN active

Antenna hole

Used to connect an antenna for optional Mini-PCIe WiFi module

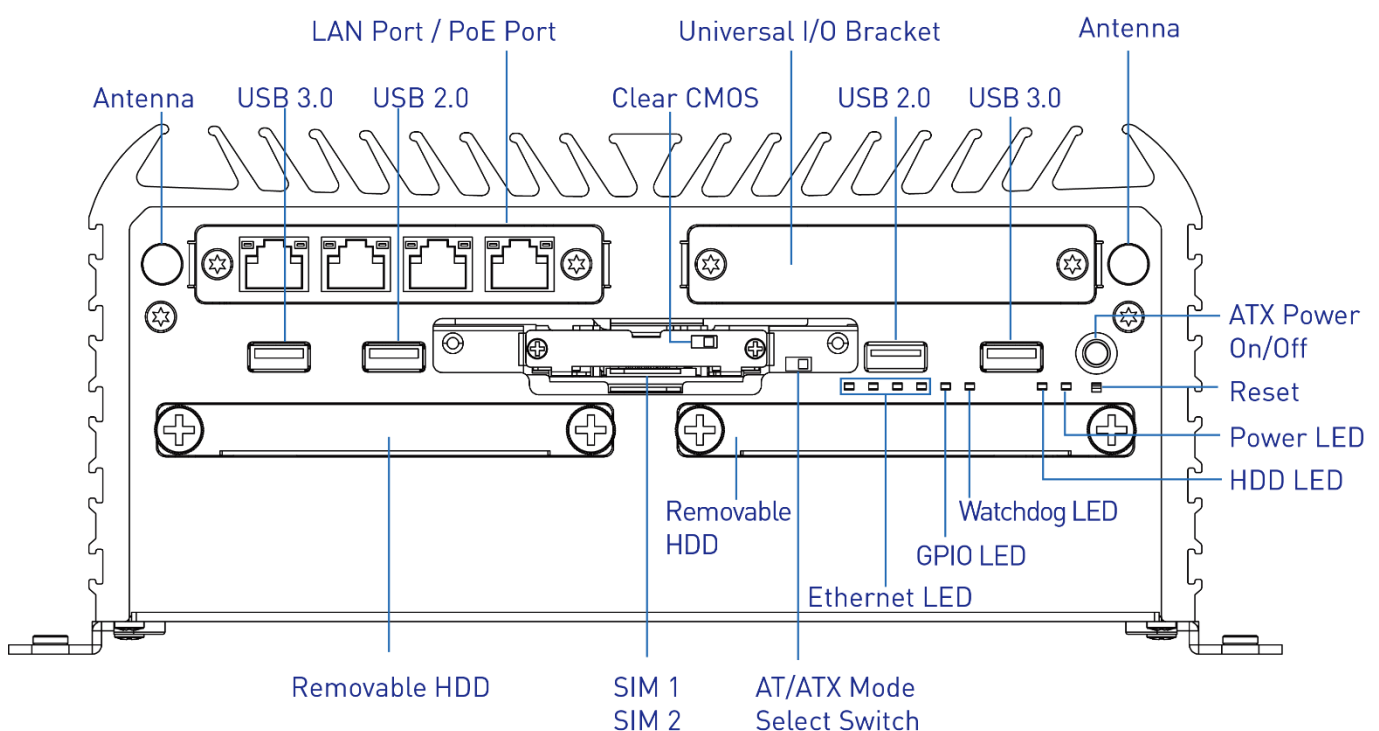

Rear Panel

DC IN

Used to plug a DC power input with terminal block

Speaker-out

Used to connect a speaker

Mic-in

Used to connect a microphone

Digital I/O Terminal Block

The Digital I/O terminal block supports 8 digital input and 8 digital output

COM port

COM1 ~ COM2 support RS232/422/485 serial device

DVI-I port

Used to connect a DVI monitor or connect optional split cable for dual display mode

DisplayPort

Used to connect a DisplayPort monitor

USB 3.0 port

Used to connect USB 3.0/2.0/1.1 device

LAN port

Used to connect the system to a local area network

Remote Power on/off Terminal Block

Used to plug a remote power on/off terminal block

Expansion Area

Used to plug PCIe Card (RCO-6011E-4L & RCO-6011E-4P Only)

Used to plug PCI Card (RCO-6011P-4L & RCO-6011P-4P Only)

Antenna hole

Used to connect an antenna for optional Mini-PCIe WiFi module

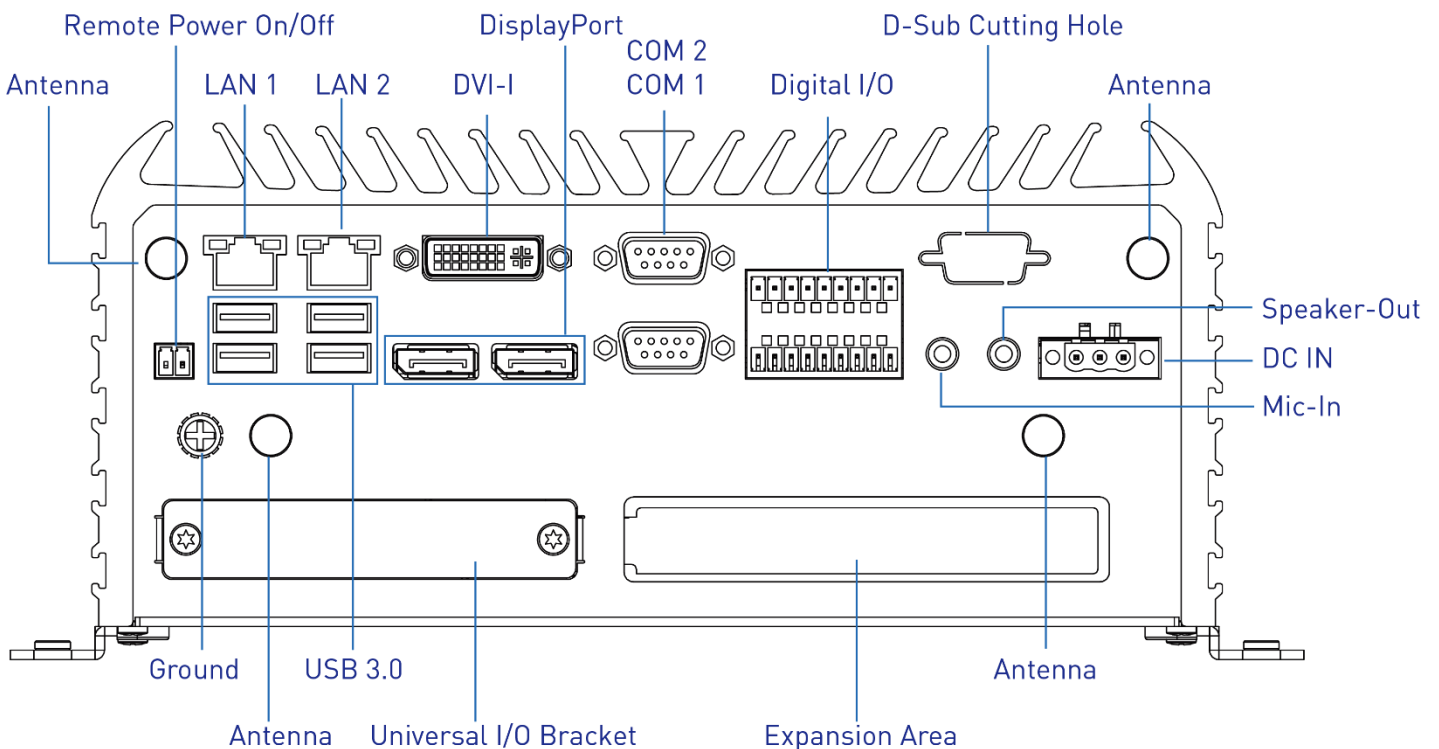

1.3.8 RCO-6011E(P)-4L(P)-M12

Front Panel

ATX power on/off switch

Press to power-on or power-off the system

Reset switch

Press to reset the system

USB 3.0 port

Used to connect USB 3.0/2.0/1.1 device

USB 2.0 port

Used to connect USB 2.0/1.1 device

AT/ATX mode select switch

Used to select AT or ATX power mode

Clear CMOS

Used to clear CMOS

SIM card

Used to insert SIM card

COM port

COM1 ~ COM2 support RS232/422/485 serial device

M12 LAN Port

Used to connect the system to a local area network
(RCO-6011E-4L-M12 & RCO-6011P-4L-M12 Only)

M12 PoE Port

Used to connect the system to a local area network with power over Ethernet
(RCO-6011E-4P-M12 & RCO-6011P-4P-M12 Only)

Universal I/O Bracket

Used to customized I/O output

HDD port

Removable 2.5" SATA HDD Area

Power LED

Indicates the power status of the system

HDD LED

Indicates the status of the hard drive

Watchdog LED

Indicates the status of the watchdog active

GPIO LED

Indicates the status of the customer define

Ethernet LEDs

Indicates the status of the LAN active

Antenna hole

Used to connect an antenna for optional Mini-PCIe WiFi module

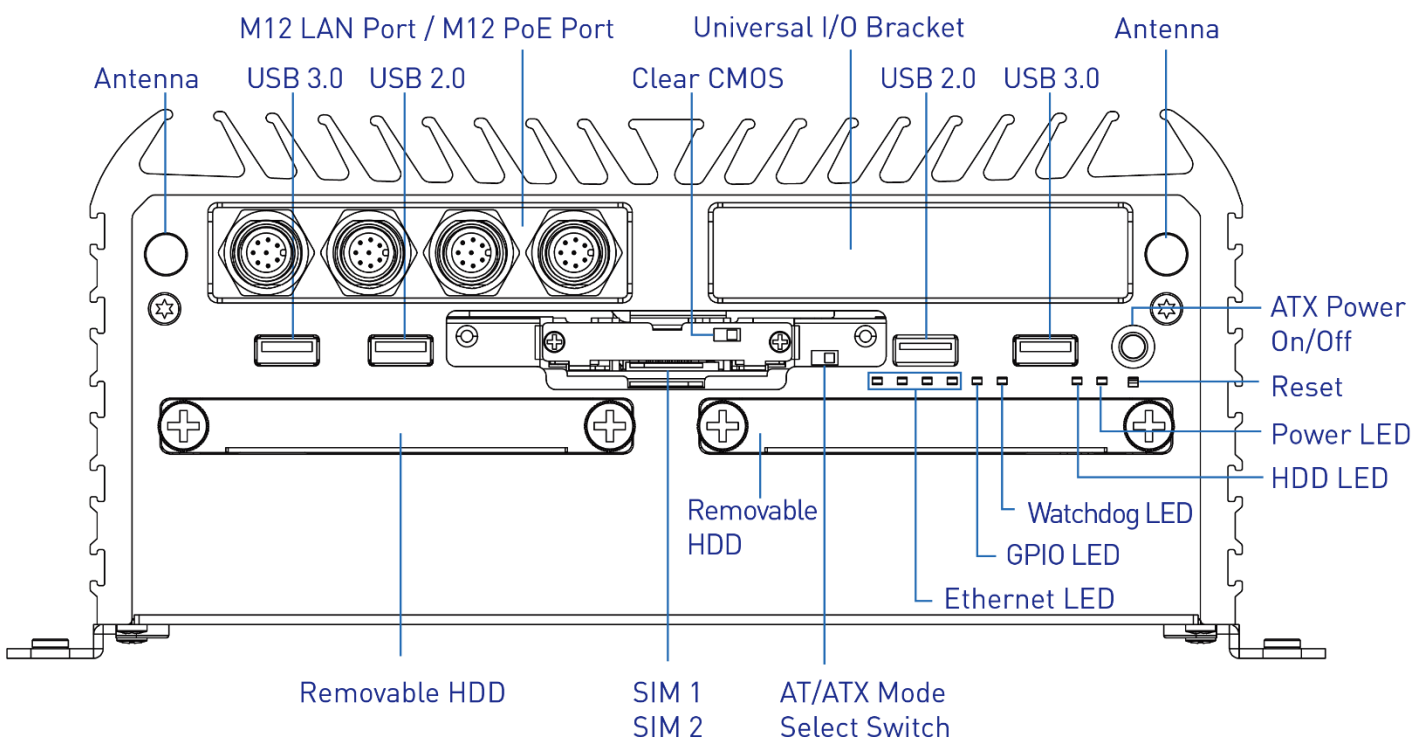

Rear Panel

DC IN

Used to plug a DC power input with terminal block

Speaker-out

Used to connect a speaker

Mic-in

Used to connect a microphone

Digital I/O Terminal Block

The Digital I/O terminal block supports 8 digital input and 8 digital output

COM port

COM1 ~ COM2 support RS232/422/485 serial device

DVI-I port

Used to connect a DVI monitor or connect optional split cable for dual display mode

DisplayPort

Used to connect a DisplayPort monitor

USB 3.0 port

Used to connect USB 3.0/2.0/1.1 device

LAN port

Used to connect the system to a local area network

Remote Power on/off Terminal Block

Used to plug a remote power on/off terminal block

Expansion Area

Used to plug PCIe Card (RCO-6011E-4L-M12 & RCO-6011E-4P-M12 Only)

Used to plug PCI Card (RCO-6011P-4L-M12 & RCO-6011P-4P-M12 Only)

Antenna hole

Used to connect an antenna for optional Mini-PCIe WiFi module

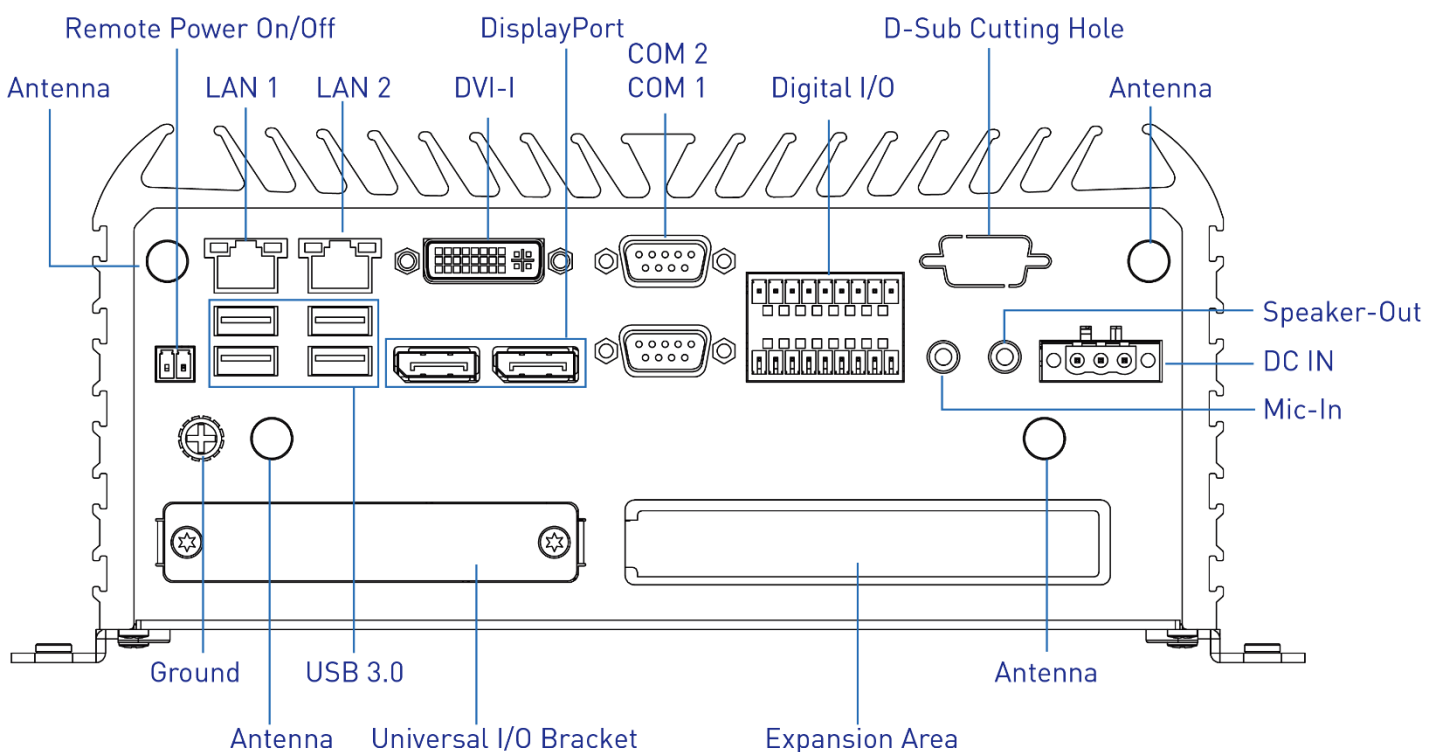

1.3.9 RCO-6011E(P)-8L(P)

Front Panel

ATX power on/off switch

Press to power-on or power-off the system

Reset switch

Press to reset the system

USB 3.0 port

Used to connect USB 3.0/2.0/1.1 device

USB 2.0 port

Used to connect USB 2.0/1.1 device

AT/ATX mode select switch

Used to select AT or ATX power mode

Clear CMOS

Used to clear CMOS

SIM card

Used to insert SIM card

COM port

COM1 ~ COM2 support RS232/422/485 serial device

LAN Port

Used to connect the system to a local area network (RCO-6011E-8L & RCO-6011P-8L Only)

PoE Port

Used to connect the system to a local area network with power over Ethernet (RCO-6011E-8P & RCO-6011P-8P Only)

HDD port

Removable 2.5" SATA HDD Area

Power LED

Indicates the power status of the system

HDD LED

Indicates the status of the hard drive

Watchdog LED

Indicates the status of the watchdog active

GPIO LED

Indicates the status of the customer define

Ethernet LEDs

Indicates the status of the LAN active

Antenna hole

Used to connect an antenna for optional Mini-PCIe WiFi module

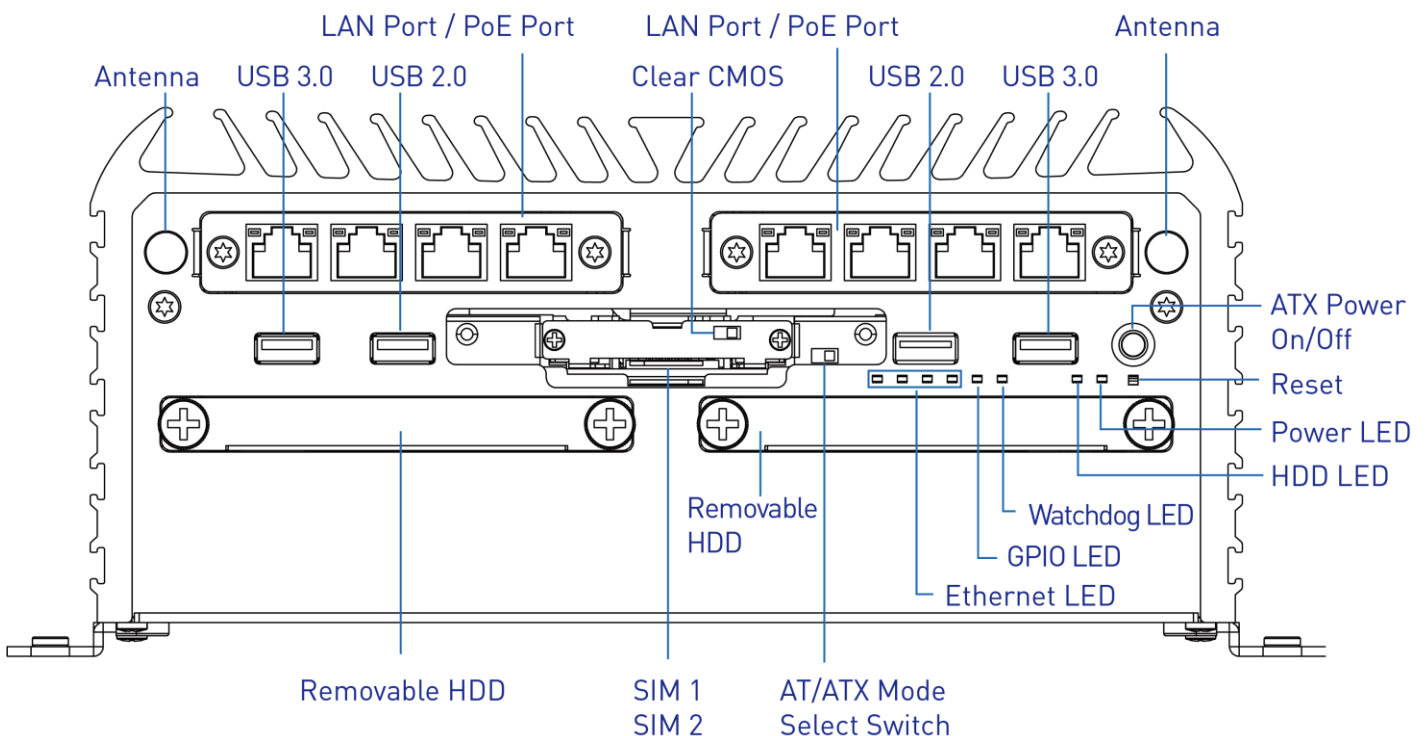

Rear Panel

DC IN

Used to plug a DC power input with terminal block

Speaker-out

Used to connect a speaker

Mic-in

Used to connect a microphone

Digital I/O Terminal Block

The Digital I/O terminal block supports 8 digital input and 8 digital output

COM port

COM1 ~ COM2 support RS232/422/485 serial device

DVI-I port

Used to connect a DVI monitor or connect optional split cable for dual display mode

DisplayPort

Used to connect a DisplayPort monitor

USB 3.0 port

Used to connect USB 3.0/2.0/1.1 device

LAN port

Used to connect the system to a local area network

Remote Power on/off Terminal Block

Used to plug a remote power on/off terminal block

Expansion Area

Used to plug PCIe Card (RCO-6011E-8L & RCO-6011E-8P Only)

Used to plug PCI Card (RCO-6011P-8L & RCO-6011P-8P Only)

Antenna hole

Used to connect an antenna for optional Mini-PCIe WiFi module

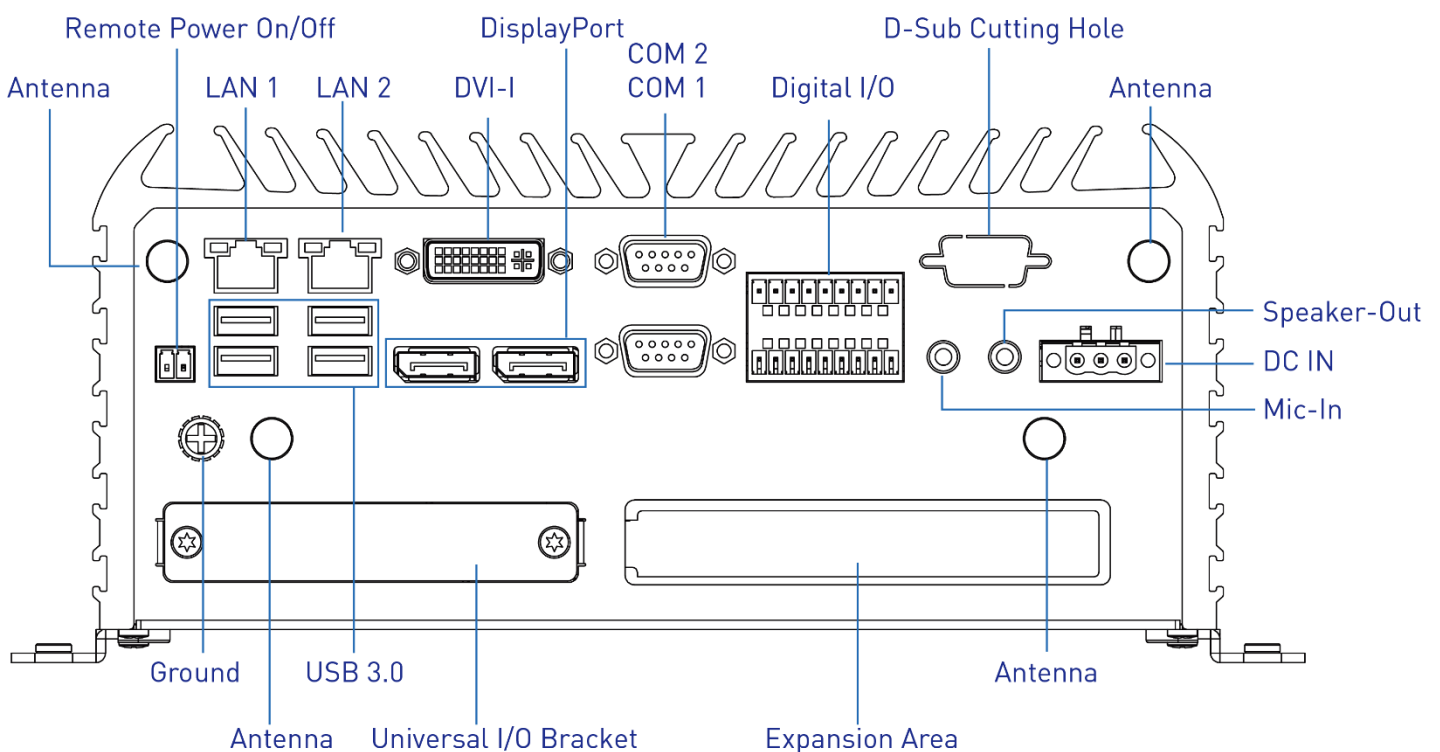

1.3.10 RCO-6011E(P)-8L(P)-M12

Front Panel

ATX power on/off switch

Press to power-on or power-off the system

Reset switch

Press to reset the system

USB 3.0 port

Used to connect USB 3.0/2.0/1.1 device

USB 2.0 port

Used to connect USB 2.0/1.1 device

AT/ATX mode select switch

Used to select AT or ATX power mode

Clear CMOS

Used to clear CMOS

SIM card

Used to insert SIM card

COM port

COM1 ~ COM2 support RS232/422/485 serial device

M12 LAN Port

Used to connect the system to a local area network (RCO-6011E-8L-M12 & RCO-6011P-8L-M12 Only)

M12 PoE Port

Used to connect the system to a local area network with power over Ethernet (RCO-6011E-8P-M12 & RCO-6011P-8P-M12 Only)

HDD port

Removable 2.5" SATA HDD Area

Power LED

Indicates the power status of the system

HDD LED

Indicates the status of the hard drive

Watchdog LED

Indicates the status of the watchdog active

GPIO LED

Indicates the status of the customer define

Ethernet LEDs

Indicates the status of the LAN active

Antenna hole

Used to connect an antenna for optional Mini-PCIe WiFi module

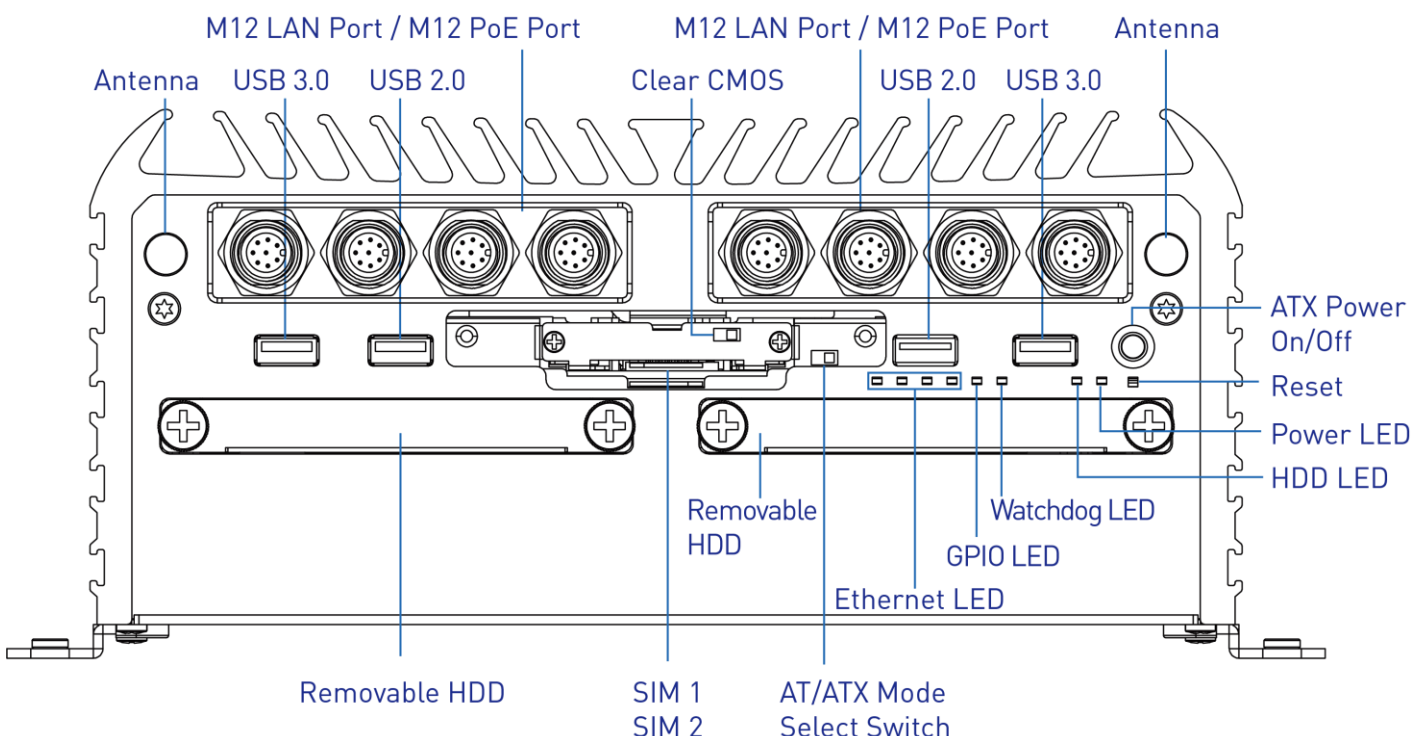

Rear Panel

DC IN

Used to plug a DC power input with terminal block

Speaker-out

Used to connect a speaker

Mic-in

Used to connect a microphone

Digital I/O Terminal Block

The Digital I/O terminal block supports 8 digital input and 8 digital output

COM port

COM1 ~ COM2 support RS232/422/485 serial device

DVI-I port

Used to connect a DVI monitor or connect optional split cable for dual display mode

DisplayPort

Used to connect a DisplayPort monitor

USB 3.0 port

Used to connect USB 3.0/2.0/1.1 device

LAN port

Used to connect the system to a local area network

Remote Power on/off Terminal Block

Used to plug a remote power on/off terminal block

Expansion Area

Used to plug PCIe Card (RCO-6011E-8L-M12 & RCO-6011E-8P-M12 Only)

Used to plug PCI Card (RCO-6011P-8L-M12 & RCO-6011P-8P-M12 Only)

Antenna hole

Used to connect an antenna for optional Mini-PCIe WiFi module

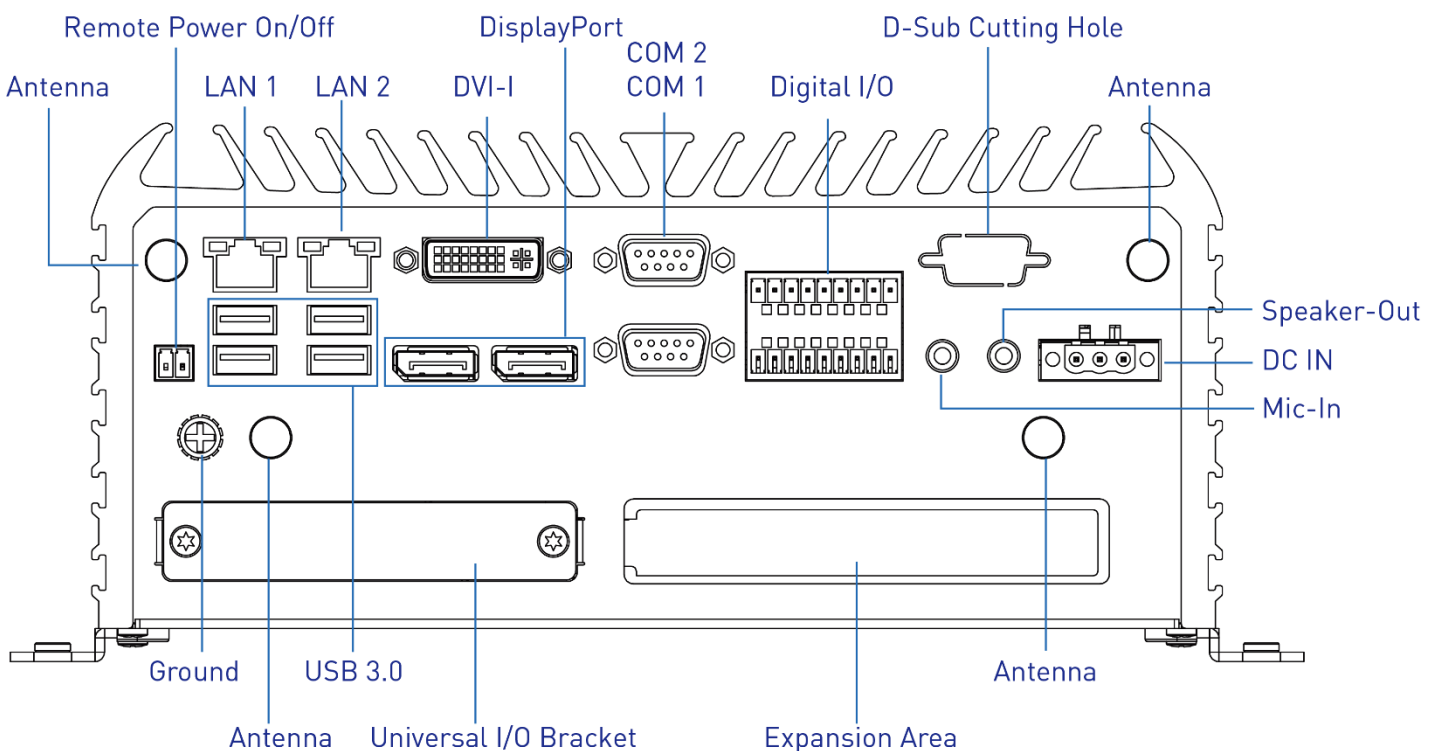

1.3.11 RCO-6022EE(PP/PE)

Front Panel

ATX power on/off switch

Press to power-on or power-off the system

Reset switch

Press to reset the system

USB 3.0 port

Used to connect USB 3.0/2.0/1.1 device

USB 2.0 port

Used to connect USB 2.0/1.1 device

AT/ATX mode select switch

Used to select AT or ATX power mode

Clear CMOS

Used to clear CMOS

SIM card

Used to insert SIM card

COM port

COM1 ~ COM2 support RS232/422/485 serial device

Universal I/O Bracket

Used to customized I/O output

HDD port

Removable 2.5" SATA HDD Area

Power LED

Indicates the power status of the system

HDD LED

Indicates the status of the hard drive

Watchdog LED

Indicates the status of the watchdog active

GPIO LED

Indicates the status of the customer define

Ethernet LEDs

Indicates the status of the LAN active

Antenna hole

Used to connect an antenna for optional Mini-PCIe WiFi module

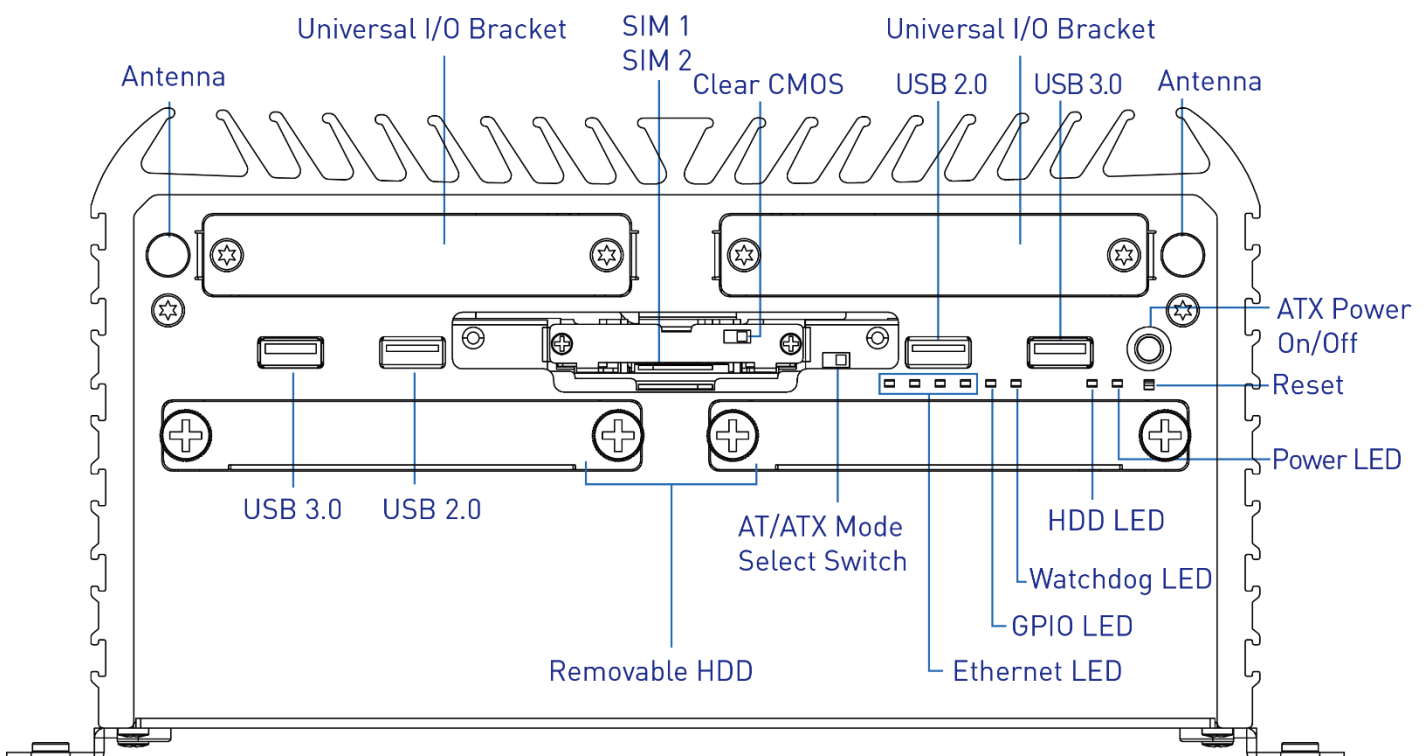

Rear Panel

DC IN

Used to plug a DC power input with terminal block

Speaker-out

Used to connect a speaker

Mic-in

Used to connect a microphone

Digital I/O Terminal Block

The Digital I/O terminal block supports 8 digital input and 8 digital output

COM port

COM1 ~ COM2 support RS232/422/485 serial device

DVI-I port

Used to connect a DVI monitor or connect optional split cable for dual display mode

DisplayPort

Used to connect a DisplayPort monitor

USB 3.0 port

Used to connect USB 3.0/2.0/1.1 device

LAN port

Used to connect the system to a local area network

Remote Power on/off Terminal Block

Used to plug a remote power on/off terminal block

Expansion Area

Used to plug PCIe Card
(RCO-6022EE & RCO-6022PE Only)

Used to plug PCI Card

(RCO-6022PP & RCO-6022PE Only)

Antenna hole

Used to connect an antenna for optional Mini-PCIe WiFi module

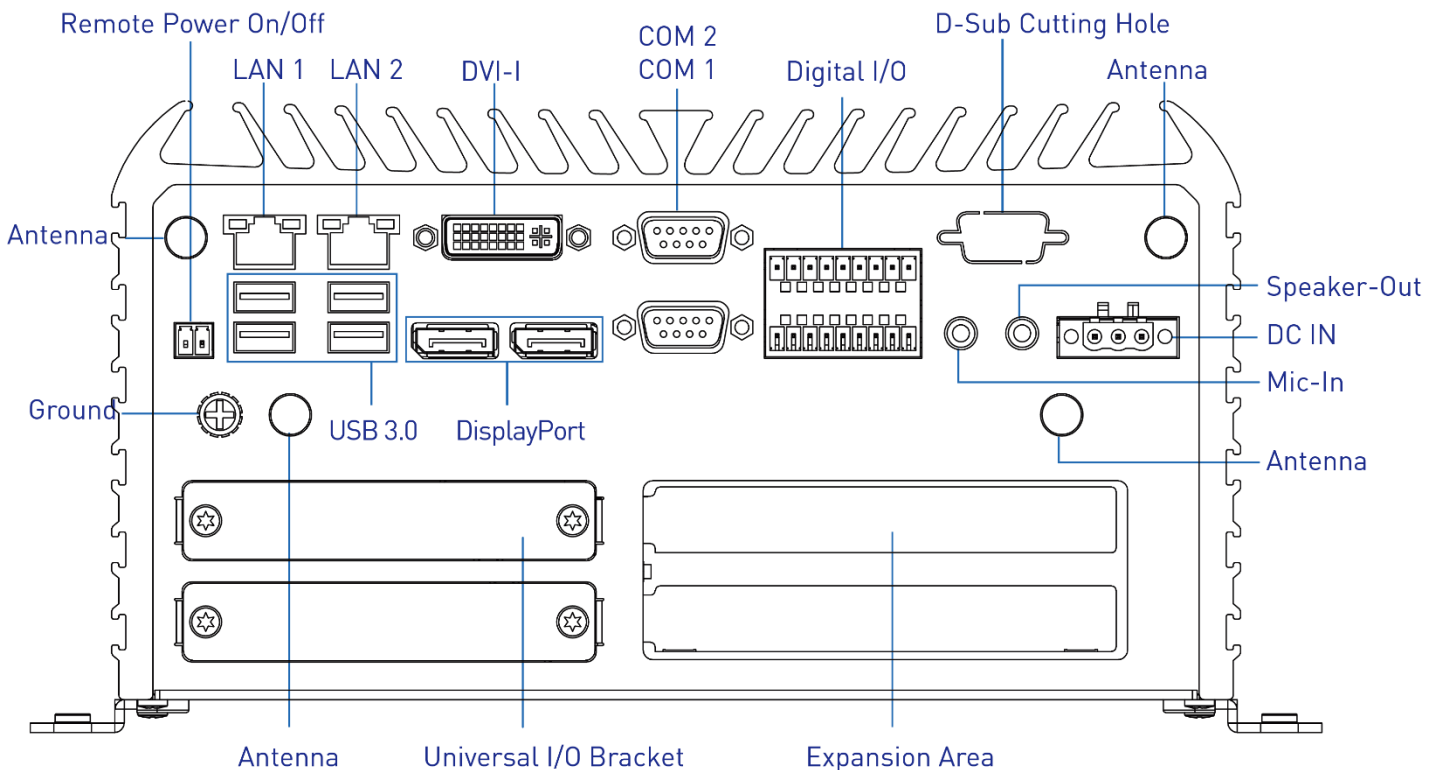

1.3.12 RCO-6022EE(PP/PE)-4L(P)

Front Panel

ATX power on/off switch

Press to power-on or power-off the system

Reset switch

Press to reset the system

USB 3.0 port

Used to connect USB 3.0/2.0/1.1 device

USB 2.0 port

Used to connect USB 2.0/1.1 device

AT/ATX mode select switch

Used to select AT or ATX power mode

Clear CMOS

Used to clear CMOS

SIM card

Used to insert SIM card

COM port

COM1 ~ COM2 support RS232/422/485 serial device

LAN Port

Used to connect the system to a local area network (RCO-6022EE-4L & RCO-6022PP-4L & RCO-6022PE-4L Only)

PoE Port

Used to connect the system to a local area network with power over Ethernet (RCO-6022EE-4P & RCO-6022PP-4P & RCO-6022PE-4P Only)

Universal I/O Bracket

Used to customized I/O output

HDD port

Removable 2.5" SATA HDD Area

Power LED

Indicates the power status of the system

HDD LED

Indicates the status of the hard drive

Watchdog LED

Indicates the status of the watchdog active

GPIO LED

Indicates the status of the customer define

Ethernet LEDs

Indicates the status of the LAN active

Antenna hole

Used to connect an antenna for optional Mini-PCIe WiFi module

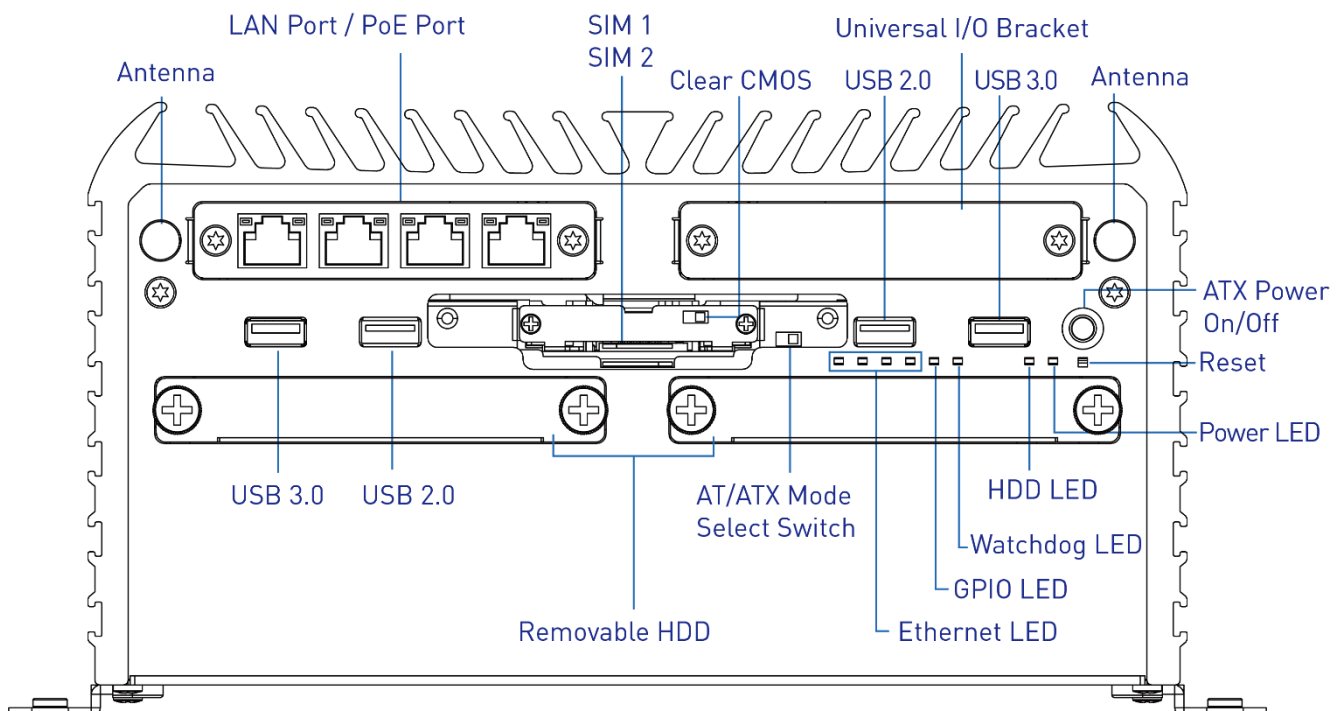

Rear Panel

DC IN

Used to plug a DC power input with terminal block

Speaker-out

Used to connect a speaker

Mic-in

Used to connect a microphone

Digital I/O Terminal Block

The Digital I/O terminal block supports 8 digital input and 8 digital output

COM port

COM1 ~ COM2 support RS232/422/485 serial device

DVI-I port

Used to connect a DVI monitor or connect optional split cable for dual display mode

DisplayPort

Used to connect a DisplayPort monitor

USB 3.0 port

Used to connect USB 3.0/2.0/1.1 device

LAN port

Used to connect the system to a local area network

Remote Power on/off Terminal Block

Used to plug a remote power on/off terminal block

Expansion Area

Used to plug PCIe Card
(RCO-6022EE-4L & RCO-6022EE-4P & RCO-6022PE-4L & RCO-6022PE-4P Only)

Used to plug PCI Card
(RCO-6022PP-4L & RCO-6022PP-4P & RCO-6022PE-4L & RCO-6022PE-4P Only)

Antenna hole

Used to connect an antenna for optional Mini-PCIe WiFi module

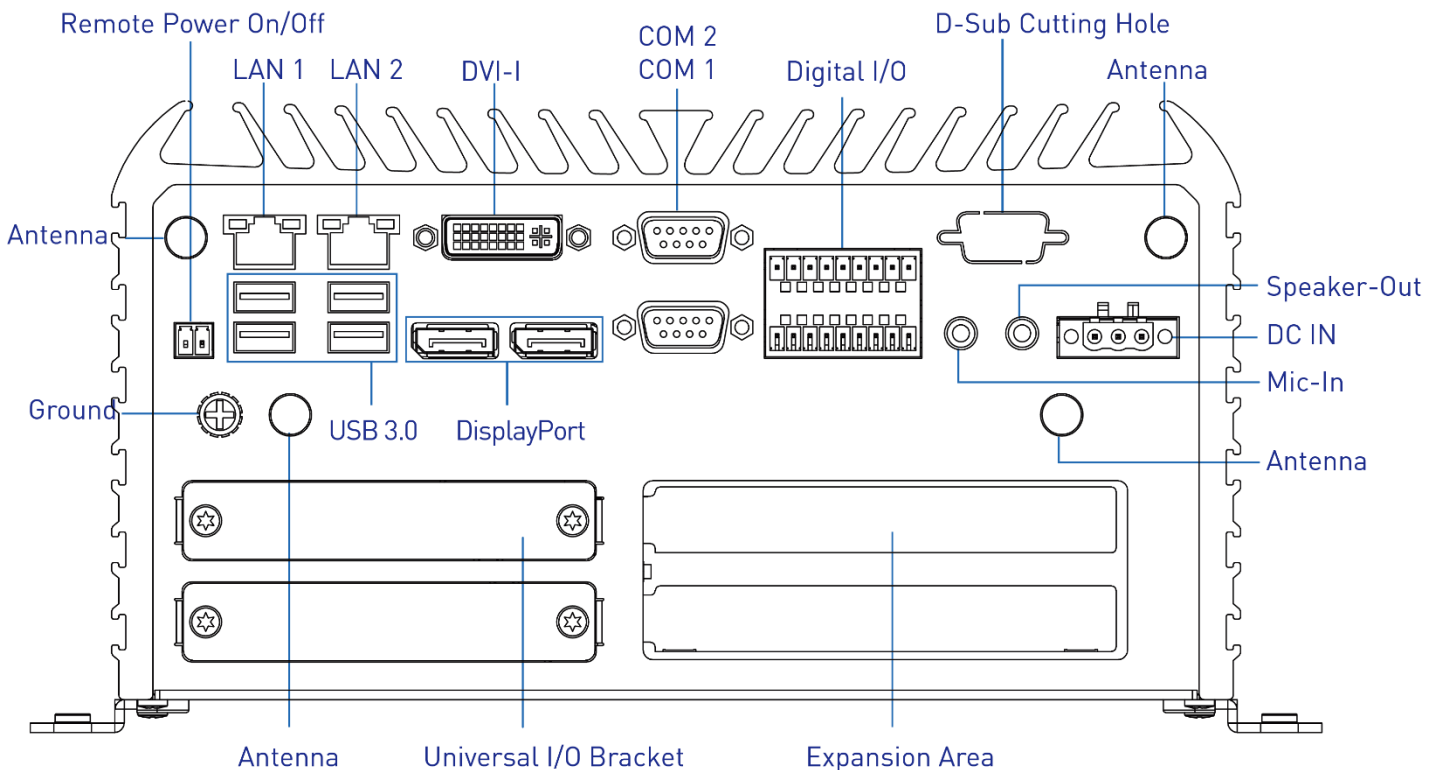

1.3.13 RCO-6022EE(PP/PE)-4L(P)-M12

Front Panel

ATX power on/off switch

Press to power-on or power-off the system

Reset switch

Press to reset the system

USB 3.0 port

Used to connect USB 3.0/2.0/1.1 device

USB 2.0 port

Used to connect USB 2.0/1.1 device

AT/ATX mode select switch

Used to select AT or ATX power mode

Clear CMOS

Used to clear CMOS

SIM card

Used to insert SIM card

COM port

COM1 ~ COM2 support RS232/422/485 serial device

M12 LAN Port

Used to connect the system to a local area network (RCO-6022EE-4L-M12 & RCO-6022PP-4L-M12 & RCO-6022PE-4L-M12 Only)

M12 PoE Port

Used to connect the system to a local area network with power over Ethernet (RCO-6022EE-4P-M12 & RCO-6022PP-4P-M12 & RCO-6022PE-4P-M12 Only)

Universal I/O Bracket

Used to customized I/O output

HDD port

Removable 2.5" SATA HDD Area

Power LED

Indicates the power status of the system

HDD LED

Indicates the status of the hard drive

Watchdog LED

Indicates the status of the watchdog active

GPIO LED

Indicates the status of the customer define

Ethernet LEDs

Indicates the status of the LAN active

Antenna hole

Used to connect an antenna for optional Mini-PCIe WiFi module

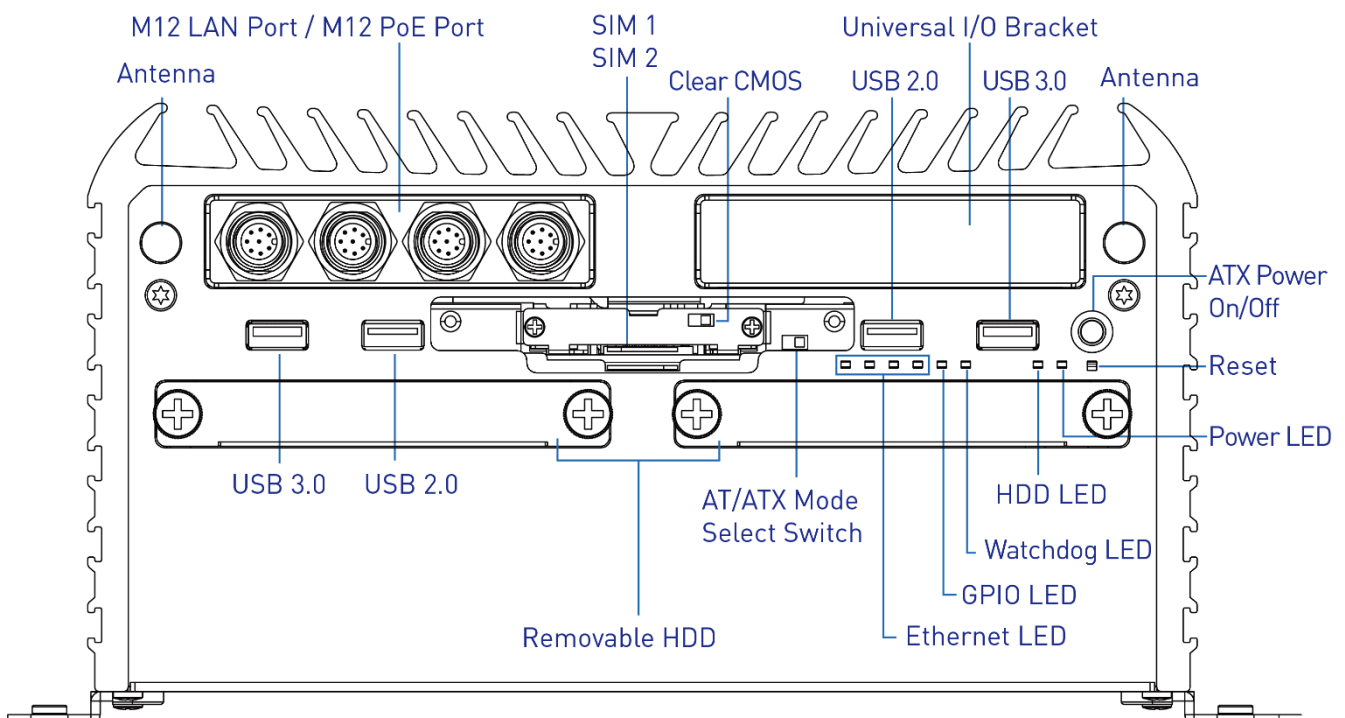

Rear Panel

DC IN

Used to plug a DC power input with terminal block

Speaker-out

Used to connect a speaker

Mic-in

Used to connect a microphone

Digital I/O Terminal Block

The Digital I/O terminal block supports 8 digital input and 8 digital output

COM port

COM1 ~ COM2 support RS232/422/485 serial device

DVI-I port

Used to connect a DVI monitor or connect optional split cable for dual display mode

DisplayPort

Used to connect a DisplayPort monitor

USB 3.0 port

Used to connect USB 3.0/2.0/1.1 device

LAN port

Used to connect the system to a local area network

Remote Power on/off Terminal Block

Used to plug a remote power on/off terminal block

Expansion Area

Used to plug PCIe Card (RCO-6022EE-4L-M12 & RCO-6022EE-4P-M12 & RCO-6022PE-4L-M12 & RCO-6022PE-4P-M12 Only)

Used to plug PCI Card (RCO-6022PP-4L-M12 & RCO-6022PP-4P-M12 & RCO-6022PE-4L-M12 & RCO-6022PE-4P-M12 Only)

Antenna hole

Used to connect an antenna for optional Mini-PCIe WiFi module

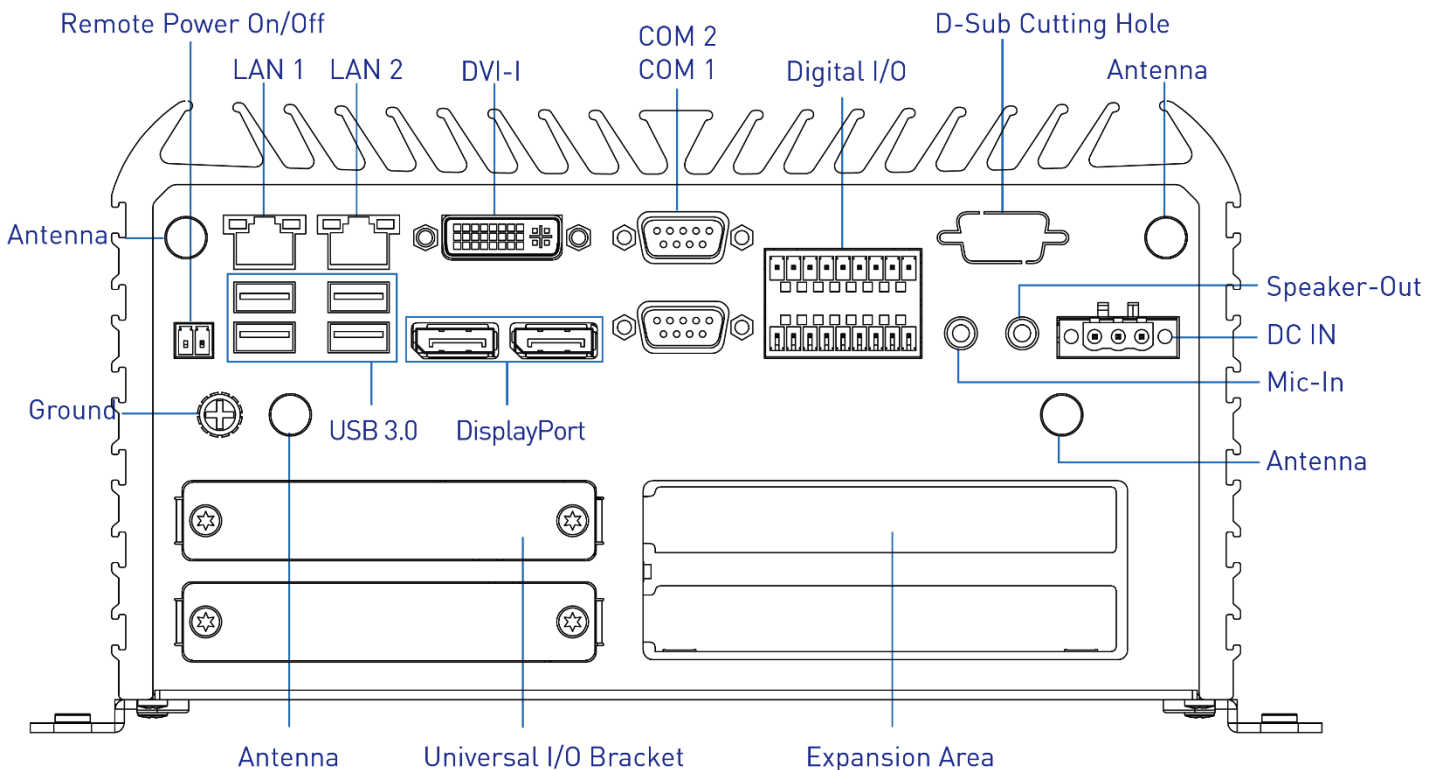

1.3.14 RCO-6022EE(PP/PE)-8L(P)

Front Panel

ATX power on/off switch

Press to power-on or power-off the system

Reset switch

Press to reset the system

USB 3.0 port

Used to connect USB 3.0/2.0/1.1 device

USB 2.0 port

Used to connect USB 2.0/1.1 device

AT/ATX mode select switch

Used to select AT or ATX power mode

Clear CMOS

Used to clear CMOS

SIM card

Used to insert SIM card

COM port

COM1 ~ COM2 support RS232/422/485 serial device

LAN Port

Used to connect the system to a local area network (RCO-6022EE-8L & RCO-6022PP-8L & RCO-6022PE-8L Only)

PoE Port

Used to connect the system to a local area network with power over Ethernet (RCO-6022EE-8P & RCO-6022PP-8P & RCO-6022PE-8P Only)

HDD port

Removable 2.5" SATA HDD Area

Power LED

Indicates the power status of the system

HDD LED

Indicates the status of the hard drive

Watchdog LED

Indicates the status of the watchdog active

GPIO LED

Indicates the status of the customer define

Ethernet LEDs

Indicates the status of the LAN active

Antenna hole

Used to connect an antenna for optional Mini-PCIe WiFi module

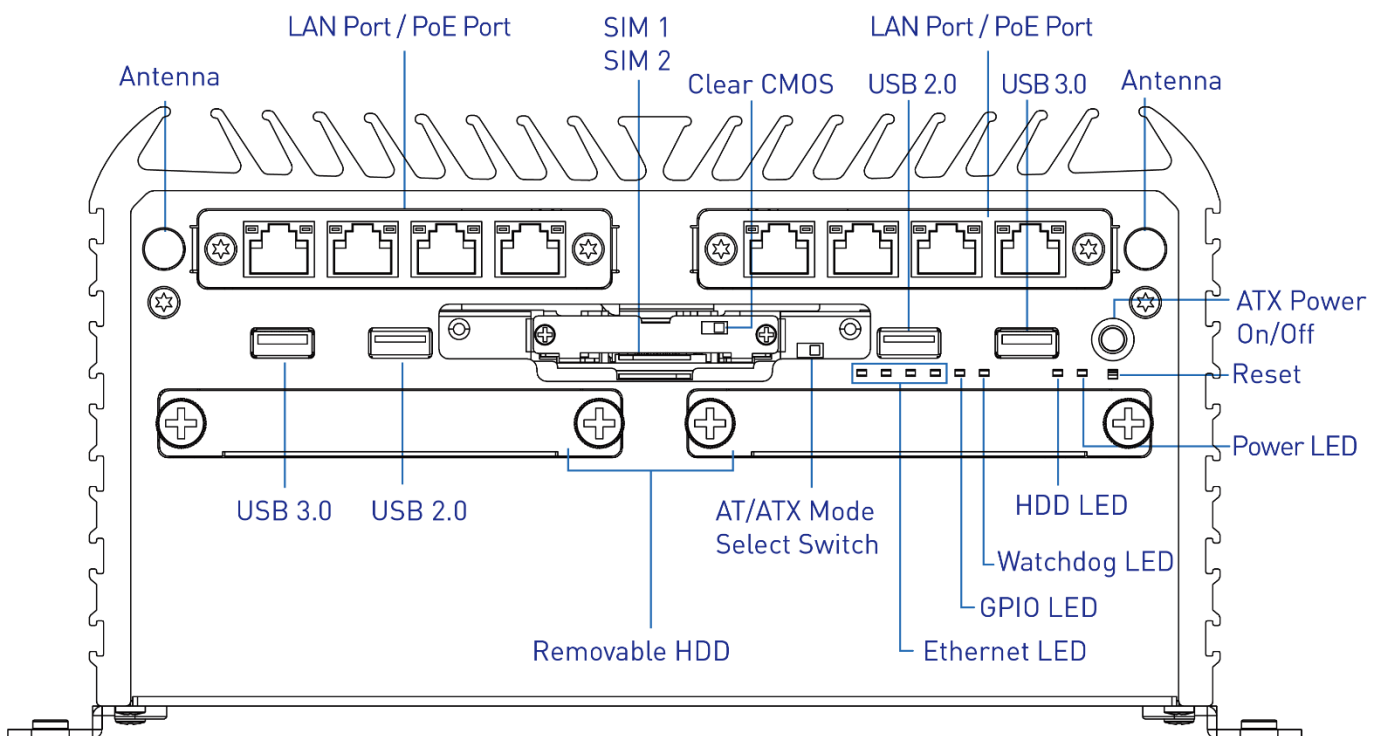

Rear Panel

DC IN

Used to plug a DC power input with terminal block

Speaker-out

Used to connect a speaker

Mic-in

Used to connect a microphone

Digital I/O Terminal Block

The Digital I/O terminal block supports 8 digital input and 8 digital output

COM port

COM1 ~ COM2 support RS232/422/485 serial device

DVI-I port

Used to connect a DVI monitor or connect optional split cable for dual display mode

DisplayPort

Used to connect a DisplayPort monitor

USB 3.0 port

Used to connect USB 3.0/2.0/1.1 device

LAN port

Used to connect the system to a local area network

Remote Power on/off Terminal Block

Used to plug a remote power on/off terminal block

Expansion Area

Used to plug PCIe Card

(RCO-6022EE-8L & RCO-6022EE-8P & RCO-6022PE-8L & RCO-6022PE-8P Only)

Used to plug PCI Card

(RCO-6022PP-8L & RCO-6022PP-8P & RCO-6022PE-8L & RCO-6022PE-8P Only)

Antenna hole

Used to connect an antenna for optional Mini-PCIe WiFi module

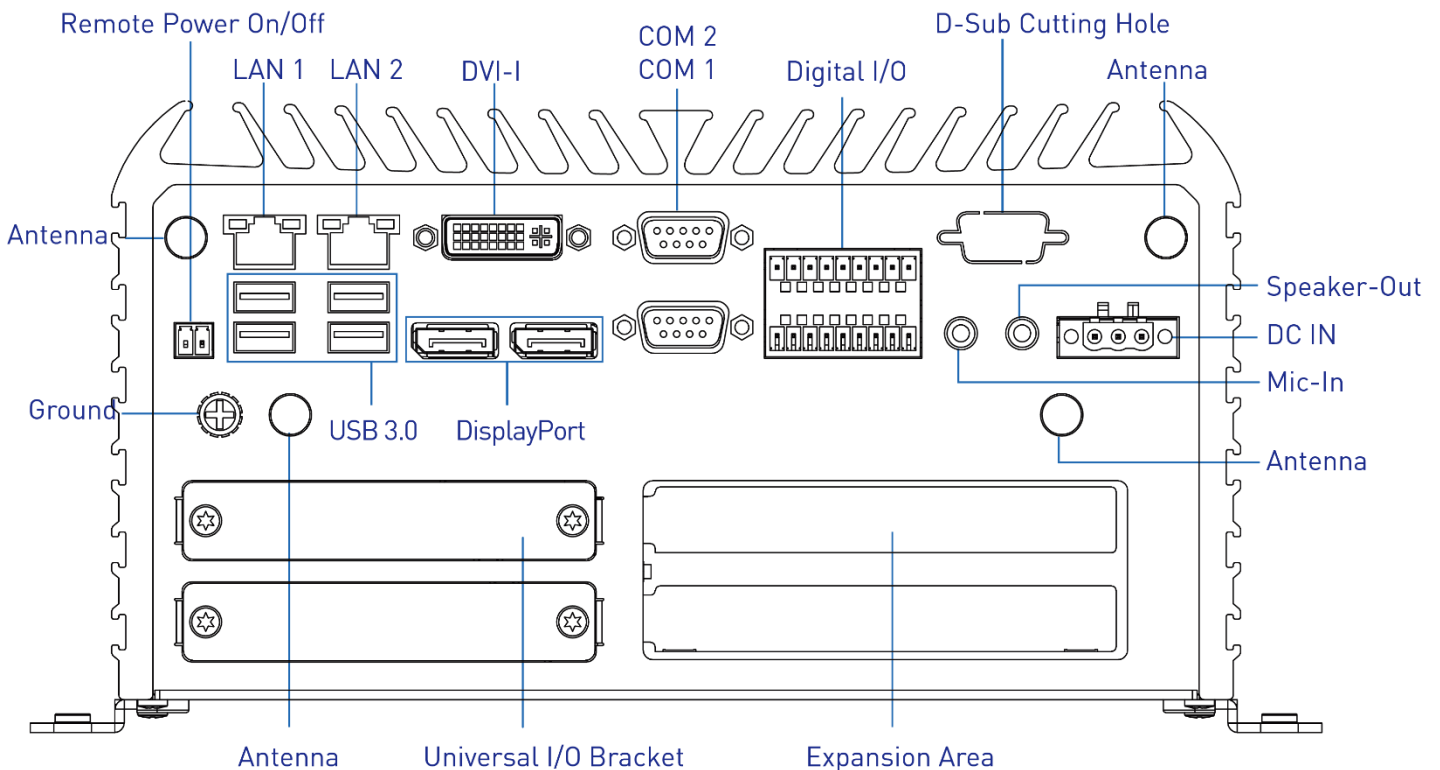

1.3.15 RCO-6022EE(PP/PE)-8L(P)-M12

Front Panel

ATX power on/off switch

Press to power-on or power-off the system

Reset switch

Press to reset the system

USB 3.0 port

Used to connect USB 3.0/2.0/1.1 device

USB 2.0 port

Used to connect USB 2.0/1.1 device

AT/ATX mode select switch

Used to select AT or ATX power mode

Clear CMOS

Used to clear CMOS

SIM card

Used to insert SIM card

COM port

COM1 ~ COM2 support RS232/422/485 serial device

M12 LAN Port

Used to connect the system to a local area network (RCO-6022EE-8L-M12 & RCO-6022PP-8L-M12 & RCO-6022PE-8L-M12 Only)

M12 PoE Port

Used to connect the system to a local area network with power over Ethernet (RCO-6022EE-8P-M12 & RCO-6022PP-8P-M12 & RCO-6022PE-8P-M12 Only)

HDD port

Removable 2.5" SATA HDD Area

Power LED

Indicates the power status of the system

HDD LED

Indicates the status of the hard drive

Watchdog LED

Indicates the status of the watchdog active

GPIO LED

Indicates the status of the customer define

Ethernet LEDs

Indicates the status of the LAN active

Antenna hole

Used to connect an antenna for optional Mini-PCIe WiFi module

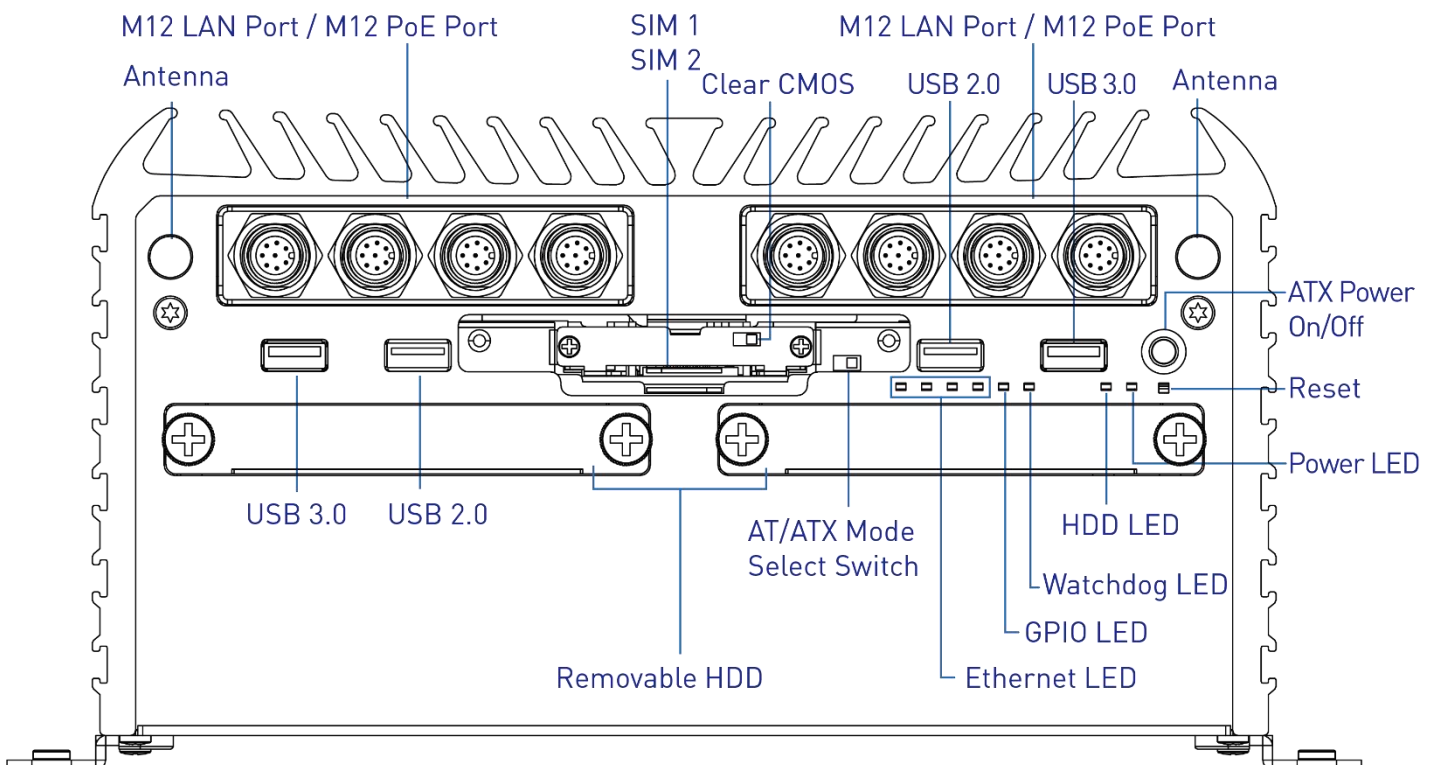

Rear Panel

DC IN

Used to plug a DC power input with terminal block

Speaker-out

Used to connect a speaker

Mic-in

Used to connect a microphone

Digital I/O Terminal Block

The Digital I/O terminal block supports 8 digital input and 8 digital output

COM port

COM1 ~ COM2 support RS232/422/485 serial device

DVI-I port

Used to connect a DVI monitor or connect optional split cable for dual display mode

DisplayPort

Used to connect a DisplayPort monitor

USB 3.0 port

Used to connect USB 3.0/2.0/1.1 device

LAN port

Used to connect the system to a local area network

Remote Power on/off Terminal Block

Used to plug a remote power on/off terminal block

Expansion Area

Used to plug PCIe Card (RCO-6022EE-8L-M12 & RCO-6022EE-8P-M12 & RCO-6022PE-8L-M12 & RCO-6022PE-8P-M12 Only)

Used to plug PCI Card (RCO-6022PP-8L-M12 & RCO-6022PP-8P-M12 & RCO-6022PE-8L-M12 & RCO-6022PE-8P-M12 Only)

Antenna hole

Used to connect an antenna for optional Mini-PCIe WiFi module

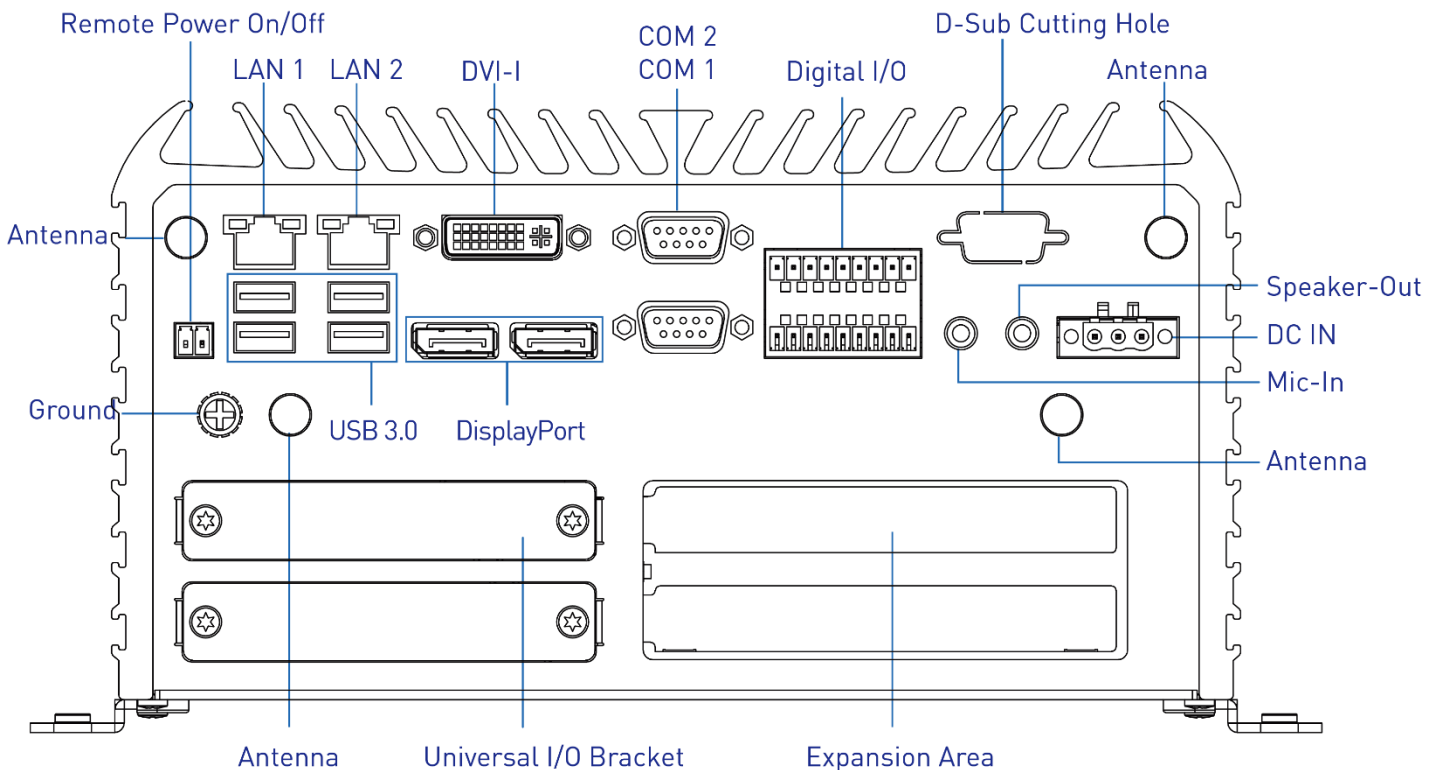

1.4 Mechanical Dimensions

1.4.1 RCO-6000 / RCO-6000-4L(P) / RCO-6000-4L(P)-M12 / RCO-6000-8L(P) / RCO-6000-8L(P)-M12

Unit: mm

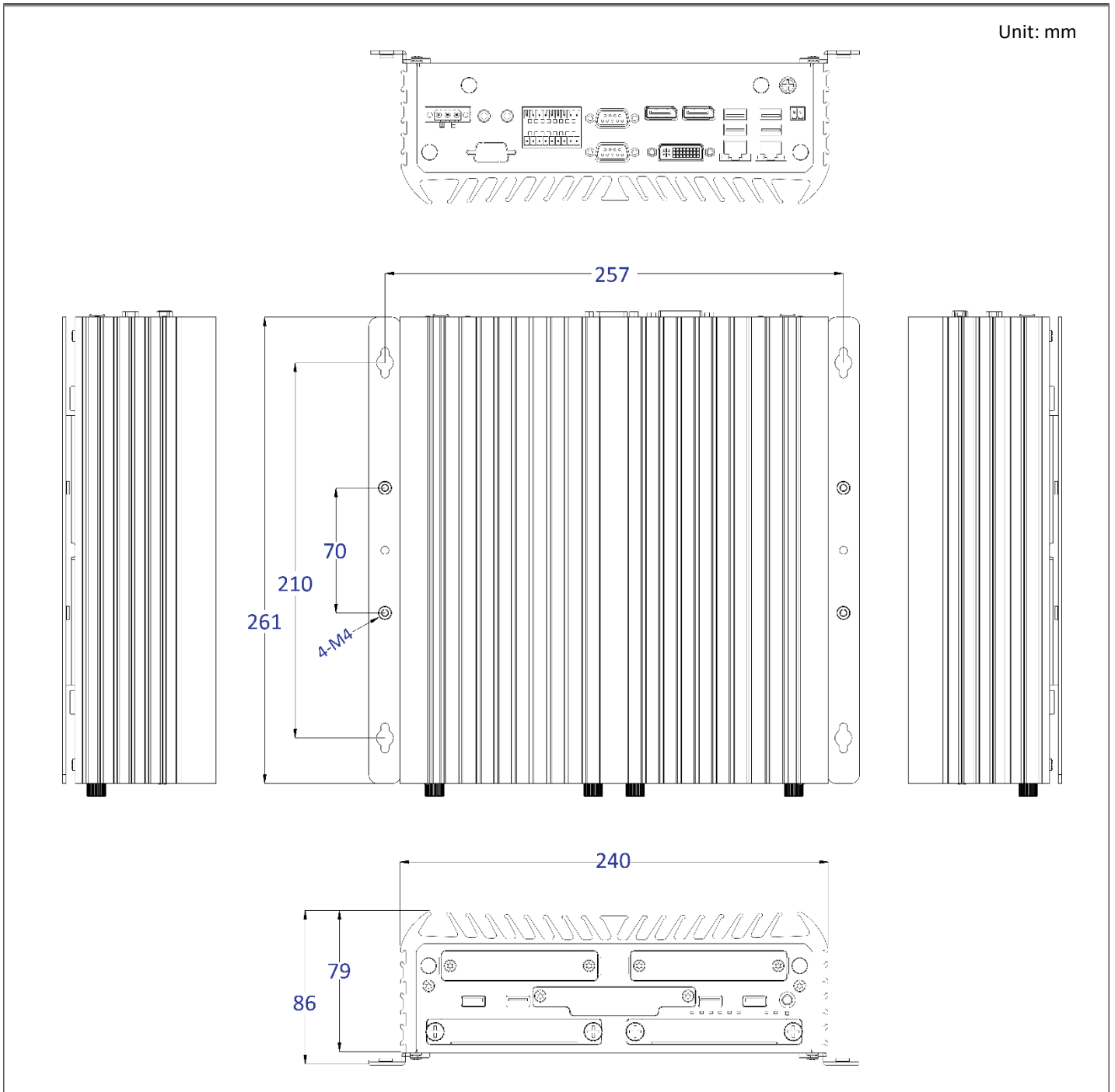

1.4.2 RCO-6011E / RCO-6011E-4L(P) / RCO-6011E-4L(P)-M12 / RCO-6011E-8L(P) / RCO-6011E-8L(P)-M12 / RCO-6011P / RCO-6011P-4L(P) / RCO-6011P-4L(P)-M12 / RCO-6011P-8L(P) / RCO-6011P-8L(P)-M12

Unit: mm

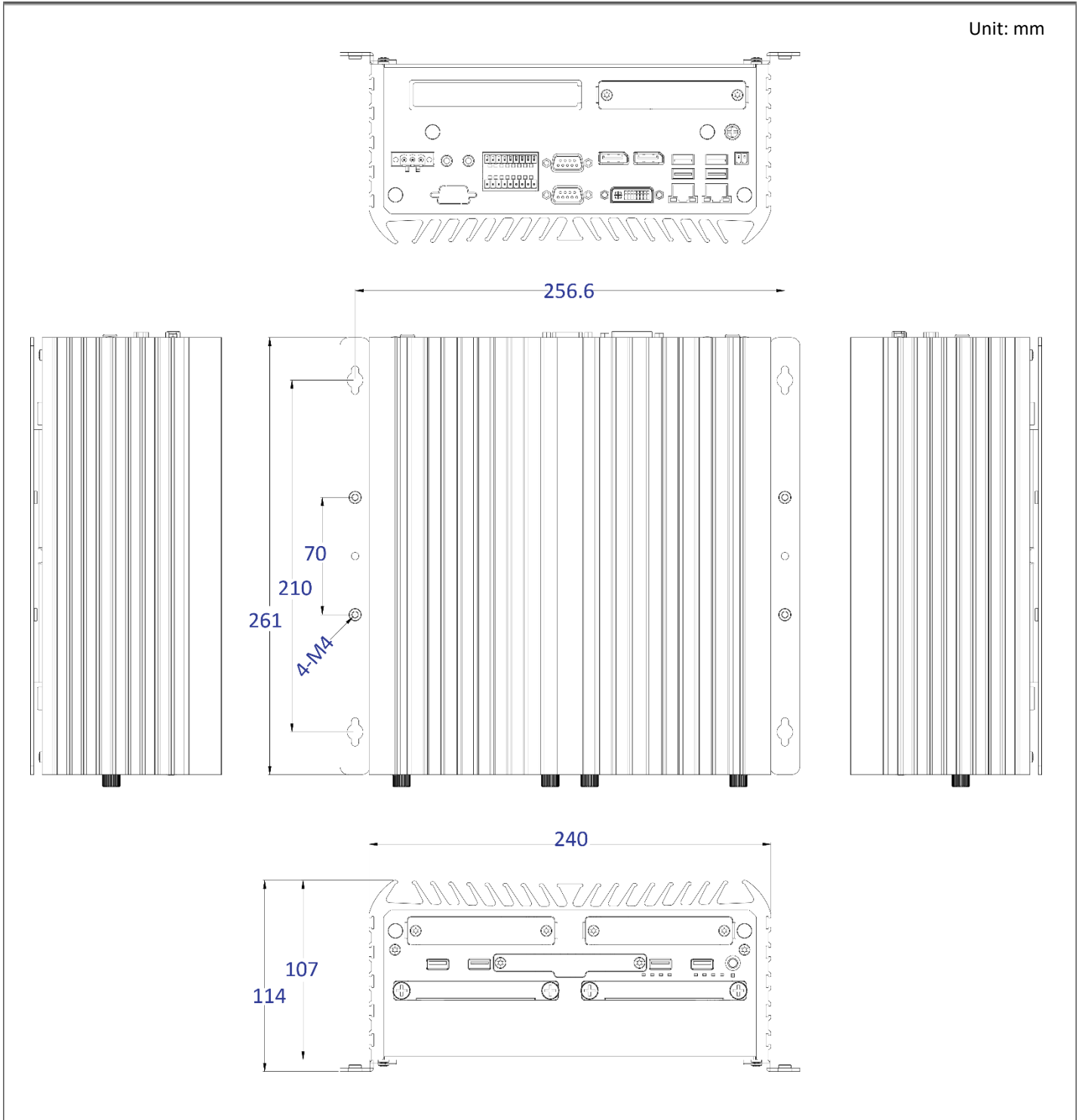

1.4.3 RCO-6022EE / RCO-6022EE-4L(P) / RCO-6022EE-4L(P)-M12 / RCO-6022EE-8L(P) / RCO-6022EE-8L(P)-M12 / RCO-6022PP / RCO-6022PP-4L(P) / RCO-6022PP-4L(P)-M12 / RCO-6022PP-8L(P) / RCO-6022PP-8L(P)-M12 / RCO-6022PE / RCO-6022PE-4L(P) / RCO-6022PE-4L(P)-M12 / RCO-6022PE-8L(P) / RCO-6022PE-8L(P)-M12

Unit: mm

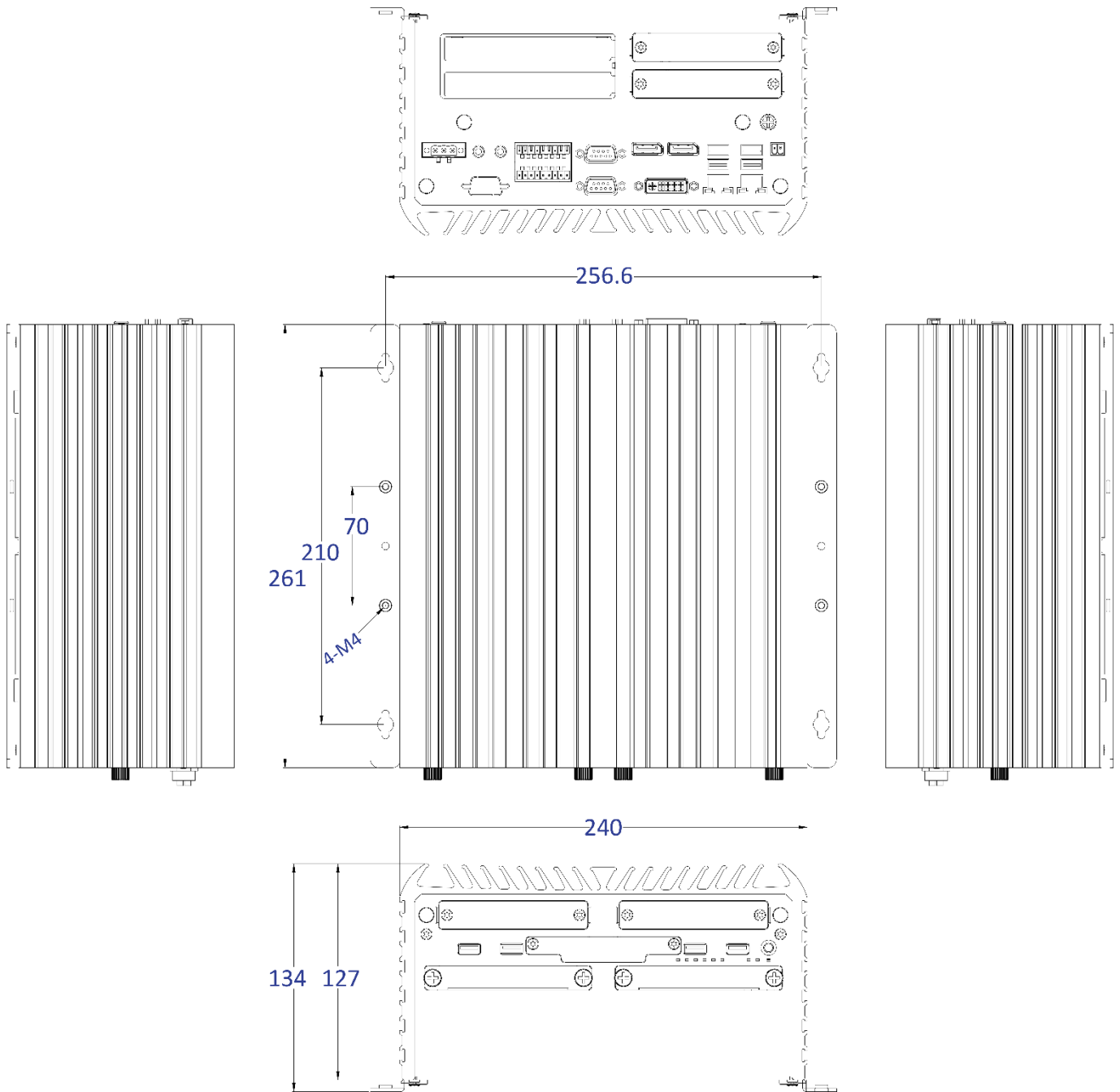

Chapter 2

Switches and Connectors

2.1 Switch and Connector Locations

2.1.1 Top View

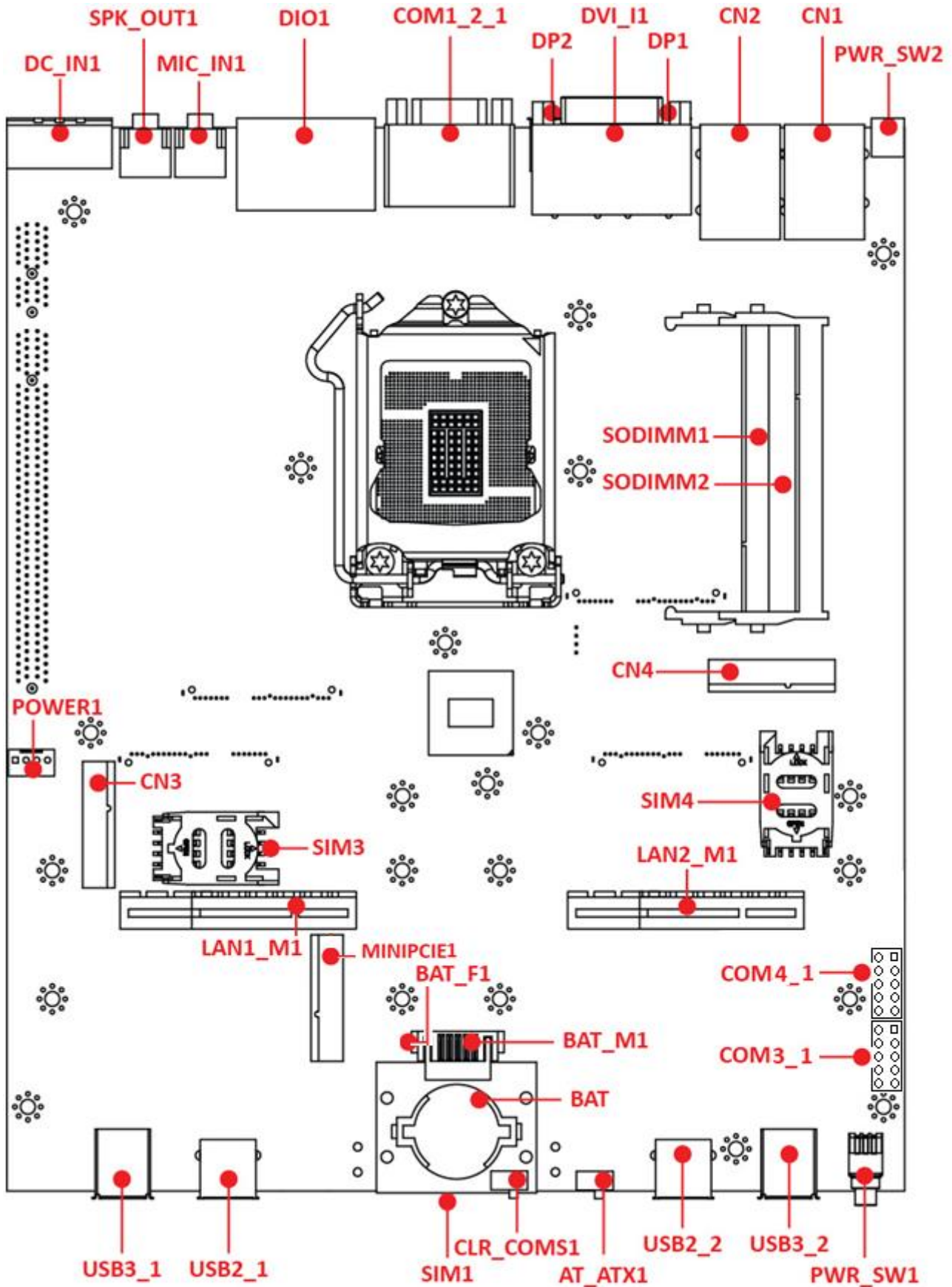

2.1.2 Bottom View

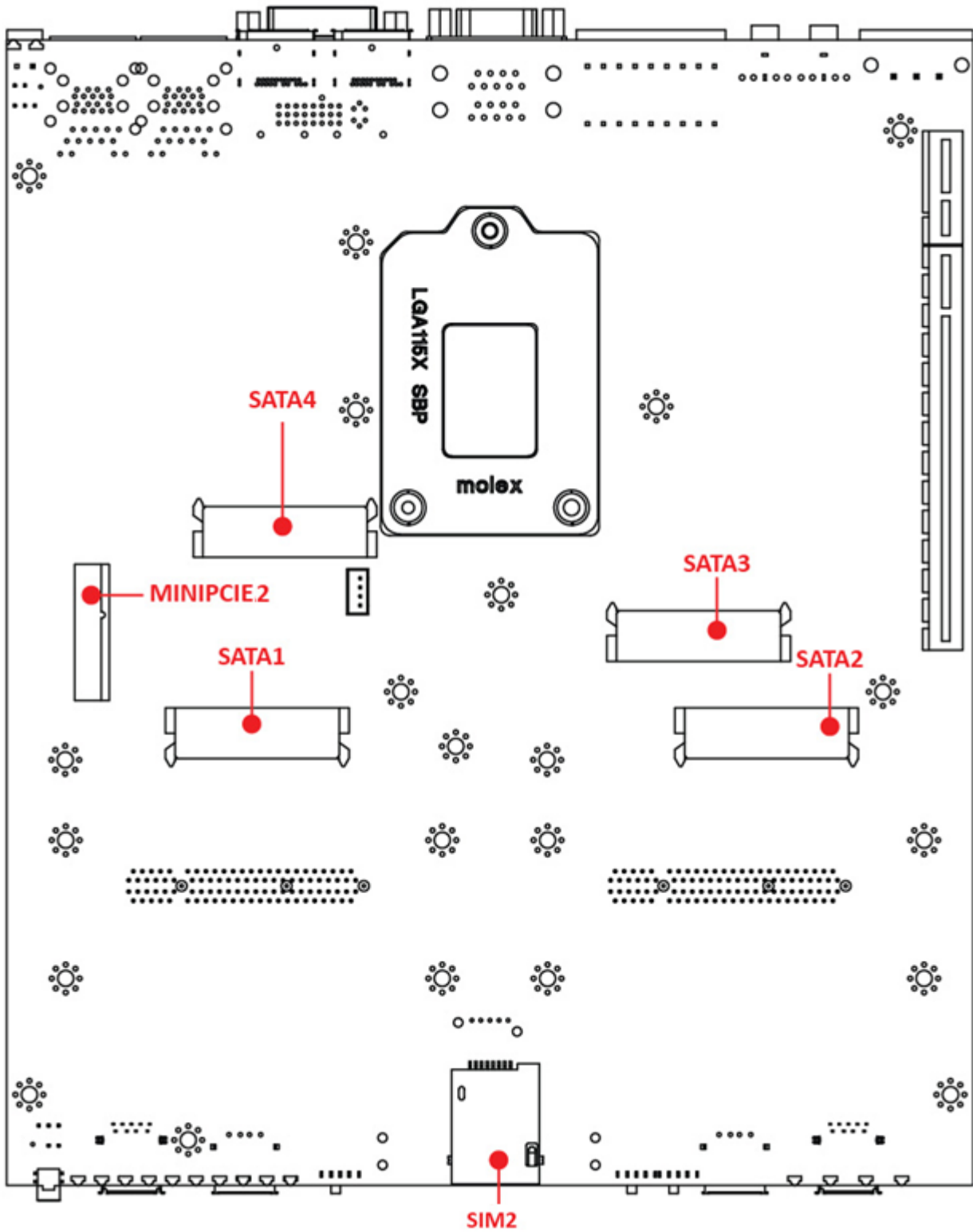

2.2 Connector / Switch Definition

List of Connector / Switch

Connector Location	Definition
AT_ATX1	AT / ATX Power Mode Switch
CLR_CMOS1	Clear BIOS Switch
PWR_SW1	Power Switch
RESET1	Reset Switch
USB3_1,USB3_2	USB 3.0 Port
USB2_1, USB2_2	USB 2.0 Port
USB2_CN1	USB 2.0 Port
SIM1, SIM2, SIM3, SIM4	SIM Card Socket
COM1_2_1	RS232 / RS422 / RS485 Connector
COM3_1, COM4_1	RS232 / RS422 / RS485 Connector
DC_IN1	3-pin DC 9~48V Power Input Connector
DVI_I1	DVI-I Connector
DP1,DP2	DisplayPort Connector
SPK_OUT1	Speaker-out Jack
MIC_IN1	Mic-in Jack
DIO1	8DI / 8DO Connector
PWR_SW2	Remote Power Switch
CN1	LAN1 and USB3.0 Ports
CN2	LAN2 and USB3.0 Ports
LAN3, LAN4, LAN5, LAN6, LAN7, LAN8, LAN9, LAN10	LAN Port / M12 LAN Port
MINIPCIE1, MINIPCIE2	Mini PCI-Express Socket
CN3, CN4	Mini PCI-Express / mSATA Socket
SATA1, SATA2, SATA3, SATA4	SATA with Power Connector
POWER1, POWER2, POWER3, POWER4	Power Connector
PCIE1	PCI-Express X1 Slot
PCIE2	PCI-Express X16 Slot
PWR_LED1	Power LED Status
HDD_LED1	HDD Access LED Status
WDT_LED1	Watchdog LED Status
GPIO_LED1	GPIO LED Status
LAN1_LINK1, LAN2_LINK1	LAN Link LED
LAN1_ACT1, LAN2_ACT1	LAN Active LED

2.3 Switches Definitions

AT_ATX1: AT / ATX Power Mode Switch

Switch	Definition
1-2 (Left)	AT Power Mode
2-3 (Right)	ATX Power Mode (Default)

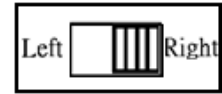

CLR_CMOS1: Clear BIOS Switch

Switch	Definition
Off	Normal Status (Default)
ON	Clear BIOS

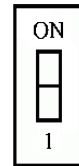

2.4 Connectors Definitions

PWR_SW1: Power Button

Pin	Definition	Pin	Definition
1	NC	4	GND
2	Power Button	5	NC
3	NC	6	GND

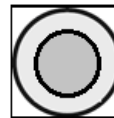

RESET1 : Reset Button

Pin	Definition
1	RESET
2	GND



USB3_1: USB3.0 Connector, Type A

Pin	Definition	Pin	Definition
1	+5V	6	USB3_RX5+
2	USB2_D5-	7	GND
3	USB2_D5+	8	USB3_TX5-
4	GND	9	USB3_TX5+
5	USB3_RX5-		

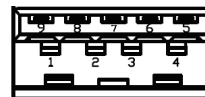

USB3_2: USB3.0 Connector, Type A

Pin	Definition	Pin	Definition
1	+5V	6	USB3_RX6+
2	USB2_D6-	7	GND
3	USB2_D6+	8	USB3_TX6-
4	GND	9	USB3_TX6+
5	USB3_RX6-		

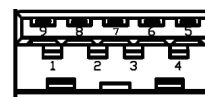

USB2_1: USB3.0 Connector, Type A

Pin	Definition
1	+5V
2	USB2_D7-
3	USB2_D7+
4	GND

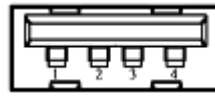

USB2_2: USB3.0 Connector, Type A

Pin	Definition
1	+5V
2	USB2_D8-
3	USB2_D8+
4	GND

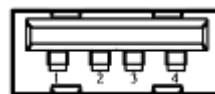

USB2_CN1: USB2.0 Ports

Connector Type: 2X5 10-pin box header, 2.0mm pitch

Pin	Definition	Pin	Definition
1	+5V	2	+5V
3	USB2_D9+	4	USB2_D10+
5	USB2_D9-	6	USB2_D10-
7	GND	8	GND
9	Cable Shield	10	Cable Shield



SIM1 : SIM Card Socket

Pin	Definition	Pin	Definition
C1	UIM1_PWR	C6	UIM1_VPP
C2	UIM1_RESET	C7	UIM1_DATA
C3	UIM1_CLK	CD	NC
C5	GND	COM	GND

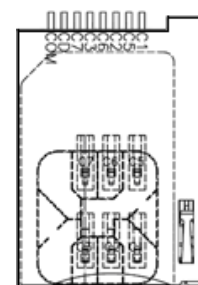

SIM2 : SIM Card Socket

Pin	Definition	Pin	Definition
C1	UIM2_PWR	C6	UIM2_VPP
C2	UIM2_RESET	C7	UIM2_DATA
C3	UIM2_CLK	CD	NC
C5	GND	COM	GND

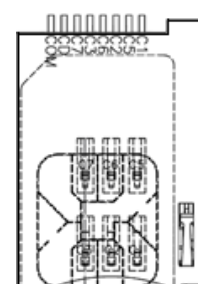

SIM3 : SIM Card Socket

Pin	Definition	Pin	Definition
C1	UIM3_PWR	C5	GND
C2	UIM3_RESET	C6	UIM3_VPP
C3	UIM3_CLK	C7	UIM3_DATA

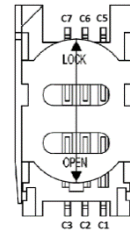

SIM4 : SIM Card Socket

Pin	Definition	Pin	Definition
C1	UIM4_PWR	C5	GND
C2	UIM4_RESET	C6	UIM4_VPP
C3	UIM4_CLK	C7	UIM4_DATA

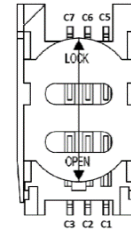

COM1_2_1: RS232 / RS422 / RS485 Connector

Connector Type: 9-pin D-Sub

COM1			
Pin	RS232 Definition	RS422 / 485 Full Duplex Definition	RS485 Half Duplex Definition
1	DCD1	TX1-	DATA1-
2	RxD1	TX1+	DATA1+
3	TxD1	RX1+	
4	DTR1	RX1-	
5	GND		
6	DSR1		
7	RTS1		
8	CTS1		
9	RI1		

COM2			
Pin	RS232 Definition	RS422 / 485 Full Duplex Definition	RS485 Half Duplex Definition
10	DCD2	TX2-	DATA2-
11	RxD2	TX2+	DATA2+
12	TxD2	RX2+	
13	DTR2	RX2-	
14	GND		
15	DSR2		
16	RTS2		
17	CTS2		
18	RI2		

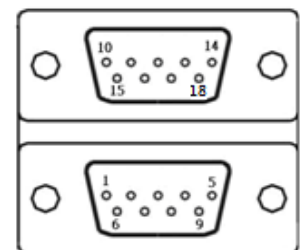

COM3_1 : RS232 / RS422 / RS485 Connector

Connector Type: 2X5 10-pin box header, 2.54mm pitch

COM3_1			
Pin	RS232 Definition	RS422 / 485 Full Duplex Definition	RS485 Half Duplex Definition
1	DCD3	TX3-	DATA3-
2	RxD3	TX3+	DATA3+
3	TxD3	RX3+	
4	DTR3	RX3-	
5	GND		
6	DSR3		
7	RTS3		
8	CTS3		
9	RI3		

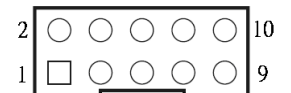

COM4_1 : RS232 / RS422 / RS485 Connector

Connector Type: 2X5 10-pin box header, 2.54mm pitch

COM4_1			
Pin	RS232 Definition	RS422 / 485 Full Duplex Definition	RS485 Half Duplex Definition
1	DCD4	TX4-	DATA4-
2	RxD4	TX4+	DATA4+
3	TxD4	RX4+	
4	DTR4	RX4-	
5	GND		
6	DSR4		
7	RTS4		
8	CTS4		
9	RI4		

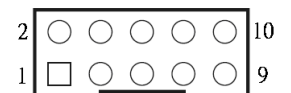

DC_IN1: DC Power Input Connector (+9~48V)

Connector Type: Terminal Block 1X3 3-pin, 5.0mm pitch

Pin	Definition
1	+9~48VIN
3	GND

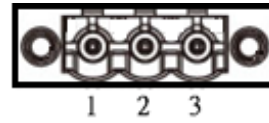

DVI_I1: DVI-I Connector

Pin	Definition	Pin	Definition
1	DVI_TX2-	16	DVI Hot Plug Detect
2	DVI_TX2+	17	DVI_TX0-
3	GND	18	DVI_TX0+
4	NC	19	GND
5	NC	20	VGA_DDC_CLOCK
6	DVI_DDC_CLOCK	21	VGA_DDC_DATA
7	DVI_DDC_DATA	22	GND
8	VGA_VSYNC	23	DVI_TXCLK+
9	DVI_TX1-	24	DVI_TXCLK-
10	DVI_TX1+	C1	VGA_RED
11	GND	C2	VGA_GREEN
12	NC	C3	VGA_BLUE
13	NC	C4	VGA_HSYNC
14	+5V	C5	GND
15	GND		

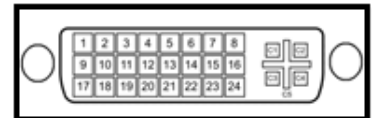

DP1: DisplayPort Connector

Pin	Definition	Pin	Definition
1	DP1_LANE0_P	11	GND
2	GND	12	DP1_LANE3_N
3	DP1_LANE0_N	13	GND
4	DP1_LANE1_P	14	GND
5	GND	15	DP1_AUX_P
6	DP1_LANE1_N	16	GND
7	DP1_LANE2_P	17	DP1_AUX_N
8	GND	18	DP1_HPD
9	DP1_LANE2_N	19	GND
10	DP1_LANE3_P	20	DP1_PWR



DP2: DisplayPort Connector

Pin	Definition	Pin	Definition
1	DP2_LANE0_P	11	GND
2	GND	12	DP2_LANE3_N
3	DP2_LANE0_N	13	GND
4	DP2_LANE1_P	14	GND
5	GND	15	DP2_AUX_P
6	DP2_LANE1_N	16	GND
7	DP2_LANE2_P	17	DP2_AUX_N
8	GND	18	DP2_HPD
9	DP2_LANE2_N	19	GND
10	DP2_LANE3_P	20	DP2_PWR



SPK_OUT1 : Speaker-out Jack (Green)

Connector Type: 5-pin Phone Jack

Pin	Definition
1	GND
2	OUT_R
3	NC
4	GND
5	OUT_L



MIC_IN1: Microphone Jack (Pink)

Connector Type: 5-pin Phone Jack

Pin	Definition
1	GND
2	MIC_R
3	NC
4	GND
5	MIC_L



DIO1: Digital Input / Output Connector

Connector Type: Terminal Block 2X9 18-pin, 3.5mm pitch

Pin	Definition	Pin	Definition
1	DI1	2	DO1
3	DI2	4	DO2
5	DI3	6	DO3
7	DI4	8	DO4
9	DI5	10	DO5
11	DI6	12	DO6
13	DI7	14	DO7
15	DI8	16	DO8
17	DC INPUT	18	GND

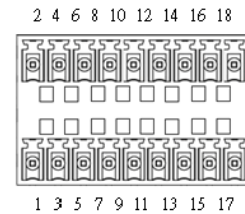

Reference Input Circuit

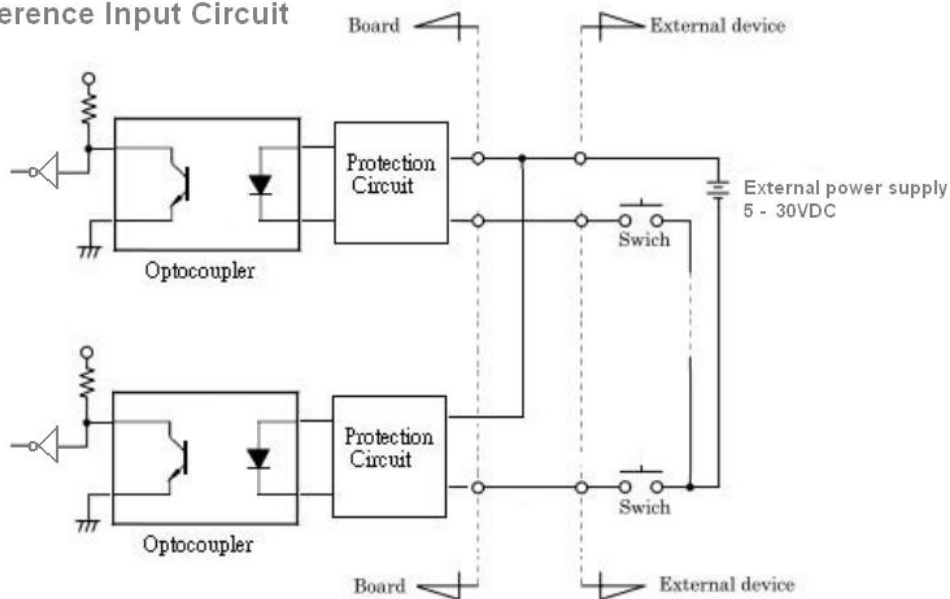

External Output Circuit

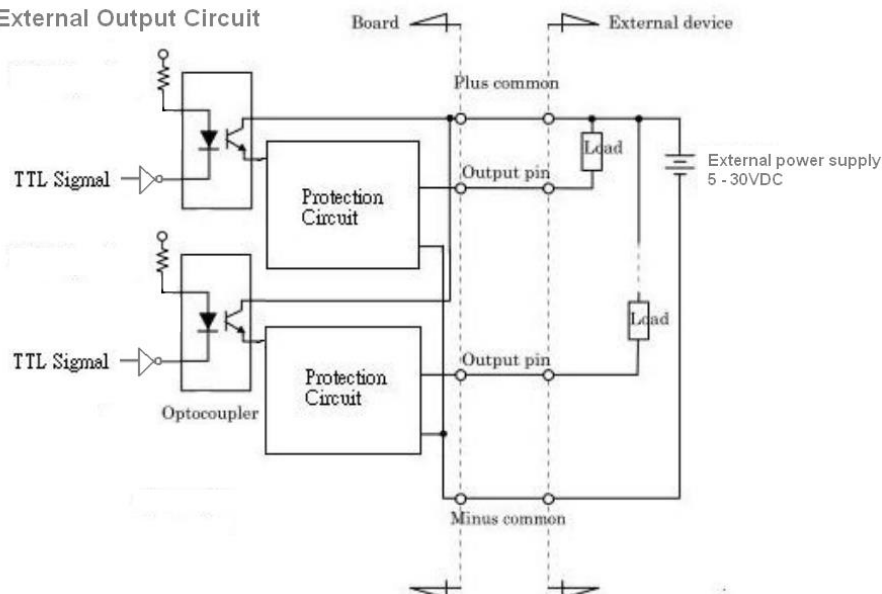

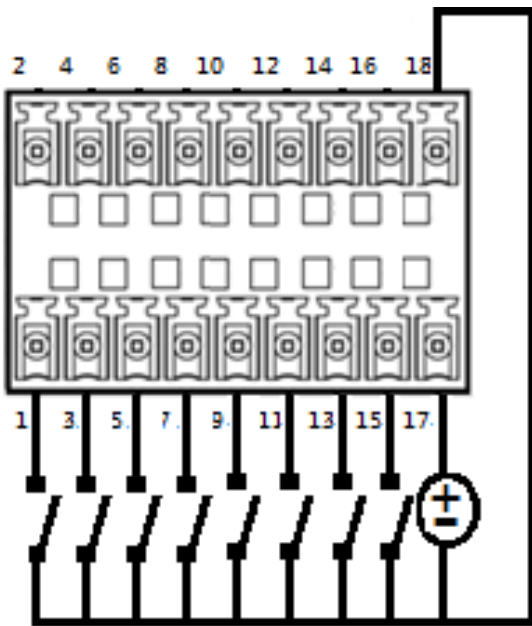

Digital Input Wurung

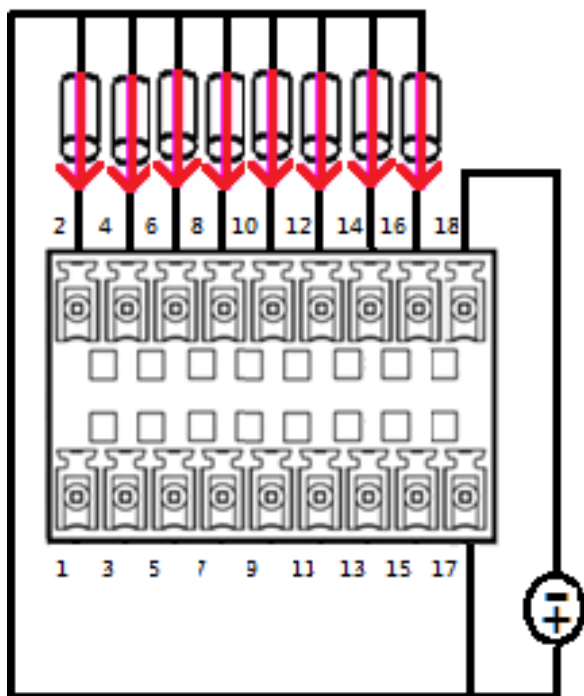

Digital Output Wurung

PWR_SW2 : Remote Power Switch

Connector Type: Terminal Block 1X2 2-pin, 3.5mm pitch

Pin	Definition
1	Power Button
2	GND



CN1: LAN1 and USB3.0 Ports

Connector Type: RJ45 port with LEDs and dual USB3.0 ports

Pin	Definition	Pin	Definition	Pin	Definition
1	+5V	10	+5V	20	LAN1_MDI0P
2	USB2_D1-	11	USB2_D2-	21	LAN1_MDI0N
3	USB2_D1+	12	USB2_D2+	22	LAN1_MDI1P
4	GND	13	GND	23	LAN1_MDI2P
5	USB3_RX1-	14	USB3_RX2-	24	LAN1_MDI2N
6	USB3_RX1+	15	USB3_RX2+	25	LAN1_MDI1N
7	GND	16	GND	26	LAN1_MDI3P
8	USB3_TX1-	17	USB3_TX2-	27	LAN1_MDI3N
9	USB3_TX1+	18	USB3_TX2+		

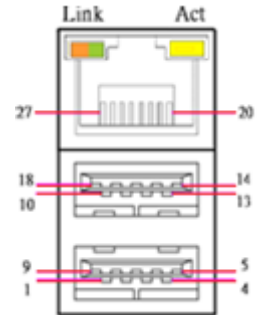

CN2: LAN2 and USB3.0 Ports

Connector Type: RJ45 port with LEDs and dual USB3.0 ports

Pin	Definition	Pin	Definition	Pin	Definition
1	+5V	10	+5V	20	LAN2_MDI0P
2	USB2_D3-	11	USB2_D4-	21	LAN2_MDI0N
3	USB2_D3+	12	USB2_D4+	22	LAN2_MDI1P
4	GND	13	GND	23	LAN2_MDI2P
5	USB3_RX3-	14	USB3_RX4-	24	LAN2_MDI2N
6	USB3_RX3+	15	USB3_RX4+	25	LAN2_MDI1N
7	GND	16	GND	26	LAN2_MDI3P
8	USB3_TX3-	17	USB3_TX4-	27	LAN2_MDI3N
9	USB3_TX3+	18	USB3_TX4+		

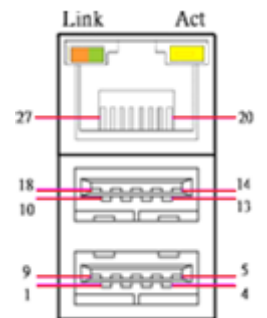

LAN3, LAN4, LAN5, LAN6, LAN7, LAN8, LAN9, LAN10 : RJ45 with LEDs Port

Connector Type: RJ45 Connector

Pin	LAN3~LAN10 Definition	Pin	LAN3~LAN10 Definition
1	LAN_MDI0P	5	LAN_MDI2N
2	LAN_MDI0N	6	LAN_MDI1N
3	LAN_MDI1P	7	LAN_MDI3P
4	LAN_MDI2P	8	LAN_MDI3N

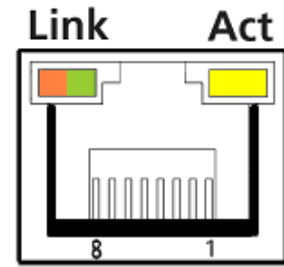

Link LED Status	LAN3~LAN10 Definition	Act LED Status	LAN3~LAN10 Definition
Steady Orange	1Gbps Network Link	Blinking Yellow	Data Activity
Steady Green	100Mbps Network Link	Off	No Activity
Off	10Mbps Network Link		

LAN3, LAN4, LAN5, LAN6, LAN7, LAN8, LAN9, LAN10 : M12 Lan Port

Connector Type: M12 X-code Female Connector

Pin	LAN3~LAN10 Definition	Pin	LAN3~LAN10 Definition
1	LAN_MDI0P	5	LAN_MDI3N
2	LAN_MDI0N	6	LAN_MDI3N
3	LAN_MDI1P	7	LAN_MDI2P
4	LAN_MDI1N	8	LAN_MDI2N

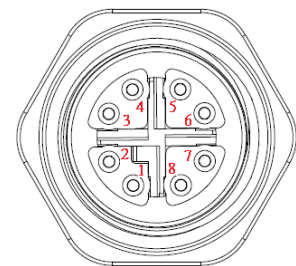

MINIPCIE1: Mini PCI-Express Socket

Pin	Definition	Pin	Definition	Pin	Definition
1	WAKE#	19	NC	37	GND
2	+3.3V	20	+3.3V	38	USB2_D11+
3	NC	21	GND	39	+3.3V
4	GND	22	MINIPCIE_RST#	40	GND
5	NC	23	MINIPCIE_RXN11	41	+3.3V
6	+1.5V	24	+3.3V	42	NC
7	CLKREQ0#	25	MINIPCIE_RXP11	43	GND
8	USIM1_VCC	26	GND	44	NC
9	GND	27	GND	45	NC
10	USIM1_DATA	28	+1.5V	46	NC
11	MINIPCIE_CLKNO	29	GND	47	NC
12	USIM1_CLK	30	SMB_CLK	48	+1.5V
13	MINIPCIE_CLKPO	31	MINIPCIE_TXN11	49	NC
14	USIM1_RST	32	SMB_DATA	50	GND
15	GND	33	MINIPCIE_TXP11	51	NC
16	USIM1_VPP	34	GND	52	+3.3V
17	NC	35	GND		
18	GND	36	USB2_D11-		

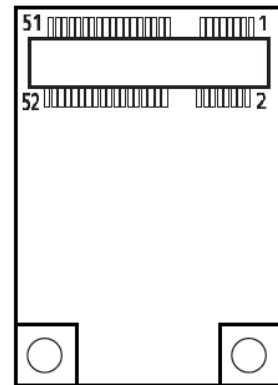
**MINIPCIE2: Mini PCI-Express Socket**

Pin	Definition	Pin	Definition	Pin	Definition
1	WAKE#	19	NC	37	GND
2	+3.3V	20	+3.3V	38	USB2_D12+
3	NC	21	GND	39	+3.3V
4	GND	22	MINIPCIE_RST#	40	GND
5	NC	23	MINIPCIE_RXN2	41	+3.3V
6	+1.5V	24	+3.3V	42	NC
7	CLKREQ2#	25	MINIPCIE_RXP2	43	GND
8	USIM2_VCC	26	GND	44	NC
9	GND	27	GND	45	NC
10	USIM2_DATA	28	+1.5V	46	NC
11	MINIPCIE_CLKN2	29	GND	47	NC
12	USIM2_CLK	30	SMB_CLK	48	+1.5V
13	MINIPCIE_CLKP2	31	MINIPCIE_TXN2	49	NC
14	USIM2_RST	32	SMB_DATA	50	GND
15	GND	33	MINIPCIE_TXP2	51	NC
16	USIM2_VPP	34	GND	52	+3.3V
17	NC	35	GND		
18	GND	36	USB2_D12-		

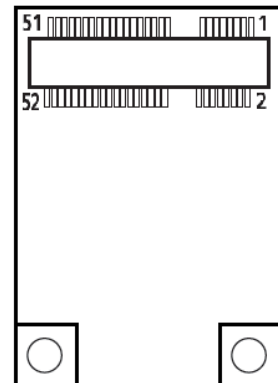

CN3: Mini PCI-Express / mSATA Socket

Pin	Definition	Pin	Definition	Pin	Definition
1	WAKE#	19	NC	37	GND
2	+3.3V	20	+3.3V	38	USB_D13+
3	NC	21	GND	39	+3.3V
4	GND	22	MINIPCIIE_RST#	40	GND
5	NC	23	MINIPCIIE_RXN4 (SATA_RXN4)	41	+3.3V
6	+1.5V	24	+3.3V	42	NC
7	CLKREQ1#	25	MINIPCIIE_RXP4 (SATA_RXP4)	43	GND
8	USIM3_VCC	26	GND	44	NC
9	GND	27	GND	45	NC
10	USIM3_DATA	28	+1.5V	46	NC
11	MINIPCIIE_CLKN4	29	GND	47	NC
12	USIM3_CLK	30	SMB_CLK	48	+1.5V
13	MINIPCIIE_CLKP4	31	MINIPCIIE_TXN4 (SATA_TXN4)	49	NC
14	USIM3_RST	32	SMB_DATA	50	GND
15	GND	33	MINIPCIIE_TXP4 (SATA_TXP4)	51	NC
16	USIM3_VPP	34	GND	52	+3.3V
17	NC	35	GND		
18	GND	36	USB_D13-		

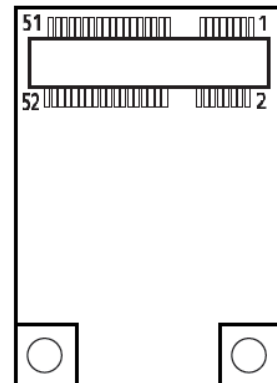
**CN4: Mini PCI-Express / mSATA Socket**

Pin	Definition	Pin	Definition	Pin	Definition
1	WAKE#	19	NC	37	GND
2	+3.3V	20	+3.3V	38	USB_D14+
3	NC	21	GND	39	+3.3V
4	GND	22	MINIPCIIE_RST#	40	GND
5	NC	23	MINIPCIIE_RXN12 (SATA_RXN5)	41	+3.3V
6	+1.5V	24	+3.3V	42	NC
7	CLKREQ3#	25	MINIPCIIE_RXP12 (SATA_RXP5)	43	GND
8	USIM4_VCC	26	GND	44	NC
9	GND	27	GND	45	NC
10	USIM4_DATA	28	+1.5V	46	NC
11	MINIPCIIE_CLKN3	29	GND	47	NC
12	USIM4_CLK	30	SMB_CLK	48	+1.5V
13	MINIPCIIE_CLKP3	31	MINIPCIIE_TXN12 (SATA_TXN5)	49	NC
14	USIM4_RST	32	SMB_DATA	50	GND
15	GND	33	MINIPCIIE_TXP12 (SATA_TXP5)	51	NC
16	USIM4_VPP	34	GND	52	+3.3V
17	NC	35	GND		
18	GND	36	USB_D14-		

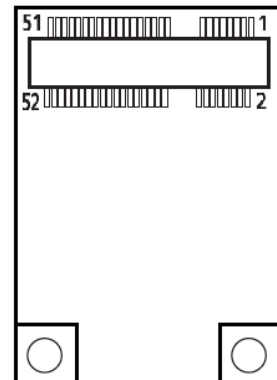

SATA1, SATA2: SATA with Power Connector

Pin	SATA1 Definition	Pin	SATA1 Definition	Pin	SATA2 Definition	Pin	SATA2 Definition
1	GND	12	GND	1	GND	12	GND
2	SATA_TXP0	13	GND	2	SATA_TXP1	13	GND
3	SATA_TXN0	14	+5V	3	SATA_TXN1	14	+5V
4	GND	15	+5V	4	GND	15	+5V
5	SATA_RXN0	16	+5V	5	SATA_RXN1	16	+5V
6	SATA_RXP0	17	GND	6	SATA_RXP1	17	GND
7	GND	18	GND	7	GND	18	GND
8	+3.3V	19	GND	8	+3.3V	19	GND
9	+3.3V	20	+12V	9	+3.3V	20	+12V
10	+3.3V	21	+12V	10	+3.3V	21	+12V
11	GND	22	+12V	11	GND	22	+12V

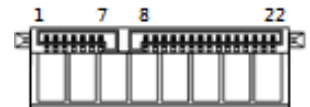

SATA3, SATA4: SATA with Power Connector

Pin	SATA1 Definition	Pin	SATA1 Definition	Pin	SATA2 Definition	Pin	SATA2 Definition
1	GND	12	GND	1	GND	12	GND
2	SATA_TXP2	13	GND	2	SATA_TXP3	13	GND
3	SATA_TXN2	14	+5V	3	SATA_TXN3	14	+5V
4	GND	15	+5V	4	GND	15	+5V
5	SATA_RXN2	16	+5V	5	SATA_RXN3	16	+5V
6	SATA_RXP2	17	GND	6	SATA_RXP3	17	GND
7	GND	18	GND	7	GND	18	GND
8	+3.3V	19	GND	8	+3.3V	19	GND
9	+3.3V	20	+12V	9	+3.3V	20	+12V
10	+3.3V	21	+12V	10	+3.3V	21	+12V
11	GND	22	+12V	11	GND	22	+12V

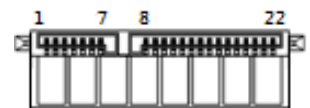

POWER1, POWER2, POWER3, POWER4: Power Connector

Connector Type: 1X4-pin Wafer, 2.0mm pitch

Pin	Definition
1	+5V
2	GND
3	GND
4	+12V

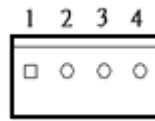

PCIE1: PCI-Express X1 Socket

Connector Type: PCI-Express X1 Slot

Pin	Definition	Pin	Definition
A1	NC	B1	+12V
A2	+12V	B2	+12V
A3	+12V	B3	+12V
A4	GND	B4	GND
A5	NC	B5	SMB_CLK
A6	NC	B6	SMB_DATA
A7	NC	B7	GND
A8	NC	B8	+3.3V
A9	+3.3V	B9	NC
A10	+3.3V	B10	+3.3VSB
A11	PCIE_RESET#	B11	PCIE_WAKE#
A12	GND	B12	+12V
A13	PCIE_CLKP1	B13	GND
A14	PCIE_CLKN1	B14	PCIE_TXP11
A15	GND	B15	PCIE_TXN11
A16	PCIE_RXP11	B16	GND
A17	PCIE_RXN11	B17	NC
A18	GND	B18	GND

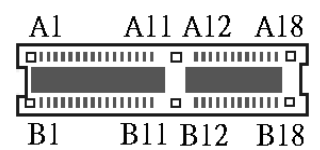

PCI-E1: PCI-Express X16 Socket

Connector Type: PCI-Express X16 Slot



Pin	Definition	Pin	Definition	Pin	Definition	Pin	Definition
A1	PCI_E_PRSENT1	A42	GND	B1	+12V	B42	PEG_TXN6
A2	+12V	A43	PEG_RXP6	B2	+12V	B43	GND
A3	+12V	A44	PEG_RXN6	B3	+12V	B44	GND
A4	GND	A45	GND	B4	GND	B45	PEG_TXP7
A5	NC	A46	GND	B5	SMB_CLK	B46	PEG_TXN7
A6	NC	A47	PEG_RXP7	B6	SMB_DATA	B47	GND
A7	NC	A48	PEG_RXN7	B7	GND	B48	PRSENT2_3
A8	NC	A49	GND	B8	+3.3V	B49	GND
A9	+3.3V	A50	NC	B9	NC	B50	PEG_TXP8
A10	+3.3V	A51	GND	B10	+3.3VSB	B51	PEG_TXN8
A11	PCI_E_RESET#	A52	PEG_RXP8	B11	PCI_E_WAKE#	B52	GND
A12	GND	A53	PEG_RXN8	B12	NC	B53	GND
A13	PEG_CLK_P	A54	GND	B13	GND	B54	PEG_TXP9
A14	PEG_CLK_N	A55	GND	B14	PEG_TXP0	B55	PEG_TXN9
A15	GND	A56	PEG_RXP9	B15	PEG_TXN0	A56	GND
A16	PEG_RXP0	A57	PEG_RXN9	B16	GND	B57	GND
A17	PEG_RXN0	A58	GND	B17	PRSENT2_1	B58	PEG_TXP10
A18	GND	A59	GND	B18	GND	B59	PEG_TXN10
A19	NC	A60	PEG_RXP10	B19	PEG_TXP1	B60	GND
A20	GND	A61	PEG_RXN10	B20	PEG_TXN1	B61	GND
A21	PEG_RXP1	A62	GND	B21	GND	B62	PEG_TXP11
A22	PEG_RXN1	A63	GND	B22	GND	B63	PEG_TXN11
A23	GND	A64	PEG_RXP11	B23	PEG_TXP2	B64	GND
A24	GND	A65	PEG_RXN11	B24	PEG_TXN2	B65	GND
A25	PEG_RXP2	A66	GND	B25	GND	B66	PEG_TXP12
A26	PEG_RXN2	A67	GND	B26	GND	B67	PEG_TXN12
A27	GND	A68	PEG_RXP12	B27	PEG_TXP3	B68	GND
A28	GND	A69	PEG_RXN12	B28	PEG_TXN3	B69	GND
A29	PEG_RXP3	A70	GND	B29	GND	B70	PEG_TXP13
A30	PEG_RXN3	A71	GND	B30	NC	B71	PEG_TXN13
A31	GND	A72	PEG_RXP13	B31	PRSENT2_2	B72	GND
A32	NC	A73	PEG_RXN13	B32	GND	B73	GND
A33	NC	A74	GND	B33	PEG_TXP4	B74	PEG_TXP14
A34	GND	A75	GND	B34	PEG_TXN4	B75	PEG_TXN14
A35	PEG_RXP4	A76	PEG_RXP14	B35	GND	B76	GND
A36	PEG_RXN4	A77	PEG_RXN14	B36	GND	B77	GND
A37	GND	A78	GND	B37	PEG_TXP5	B78	PEG_TXP15
A38	GND	A79	GND	B38	PEG_TXN5	B79	PEG_TXN15
A39	PEG_RXP5	A80	PEG_RXP15	B39	GND	B80	GND
A40	PEG_RXN5	A81	PEG_RXN15	B40	GND	B81	PRSENT2_4
A41	GND	A82	GND	B41	PEG_TXP6	B82	NC

PWR_LED1: Power LED Status

Pin	Definition
1	POWER LED+
2	POWER LED-

**HDD_LED1: HDD Access LED Status**

Pin	Definition
1	HDD LED+
2	HDD LED-

**WDT_LED1: Watchdog LED Status**

Pin	Definition
1	WATCHDOG LED+
2	WATCHDOG LED-

**GPIO_LED1: GPIO LED Status**

Pin	Definition
1	GPIO LED+
2	GPIO LED-

**LAN1_LINK1, LAN2_LINK1 : LAN Link LED Status**

Pin	Definition
1	LINK LED+
2	LINK LED-100Mbps-
3	LINK LED 100Mbps-

**LAN1_ACT1, LAN2_ACT1 : LAN Active LED Status**

Pin	Definition
1	ACTIVE LED+
2	ACTIVE LED-



Chapter 3

System Setup

3.1 Set torque force to 3.5 kgf-cm to execute all the screwing and unscrewing.

3.2 Removing chassis bottom cover

**WARNING**

In order to prevent electric shock or system damage, before removing the chassis cover, must turn off power and disconnect the unit from power source.

1. Turn the system upside down. Unscrew the 6 screws (M3x5L) on the bottom cover.



2. Now you can remove the bottom cover.

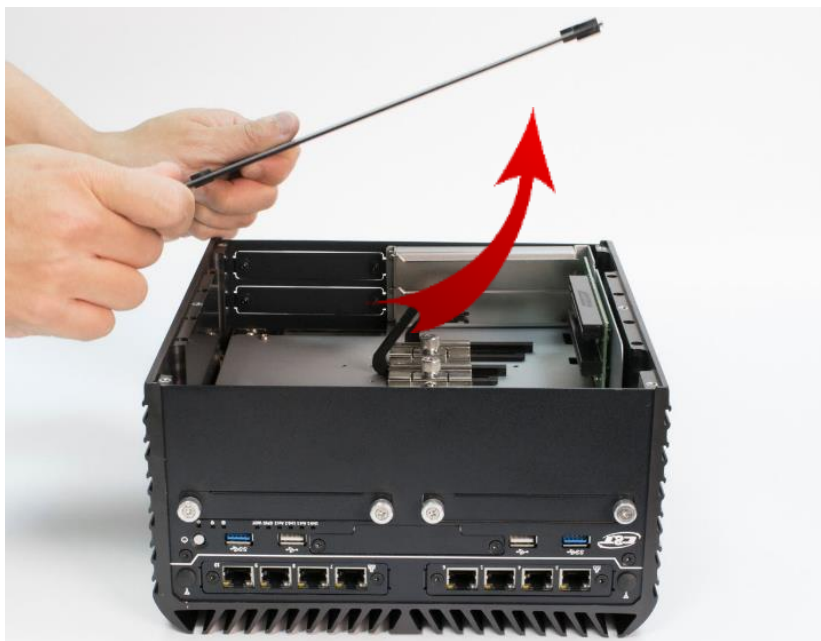

3.3 Removing PCIe/PCI expansion module

1. This step only applies to RCO-6011 and RCO-6022 series, which is equipped with PCIe/PCI expansion module.
2. Unscrew four screws (M3x5L) circled below.

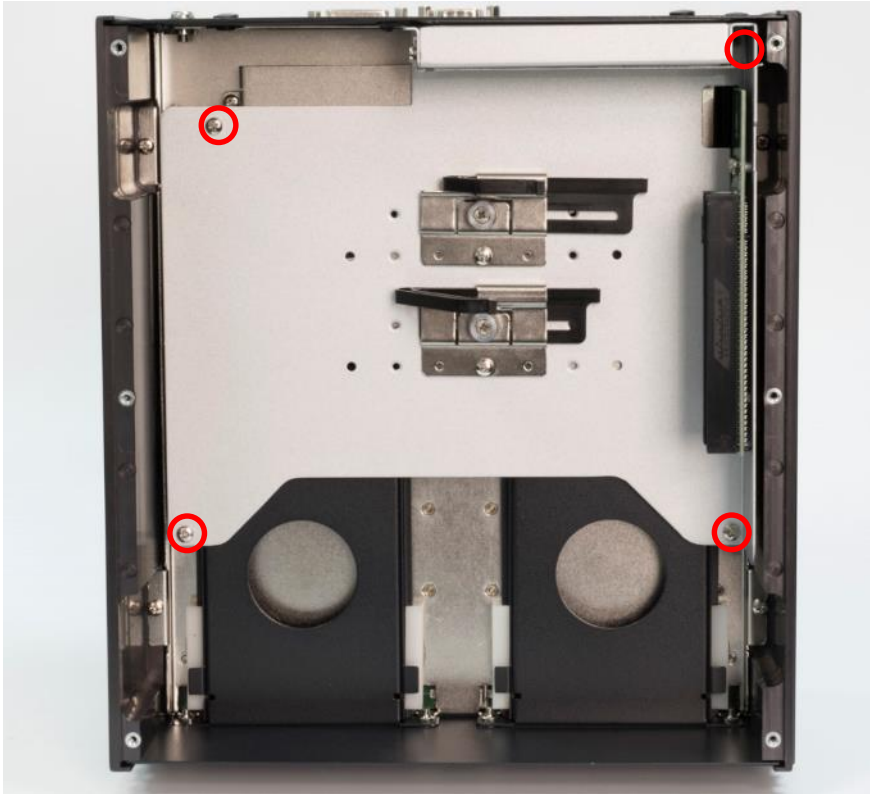

3. Now you can remove the PCIe/PCI expansion module.

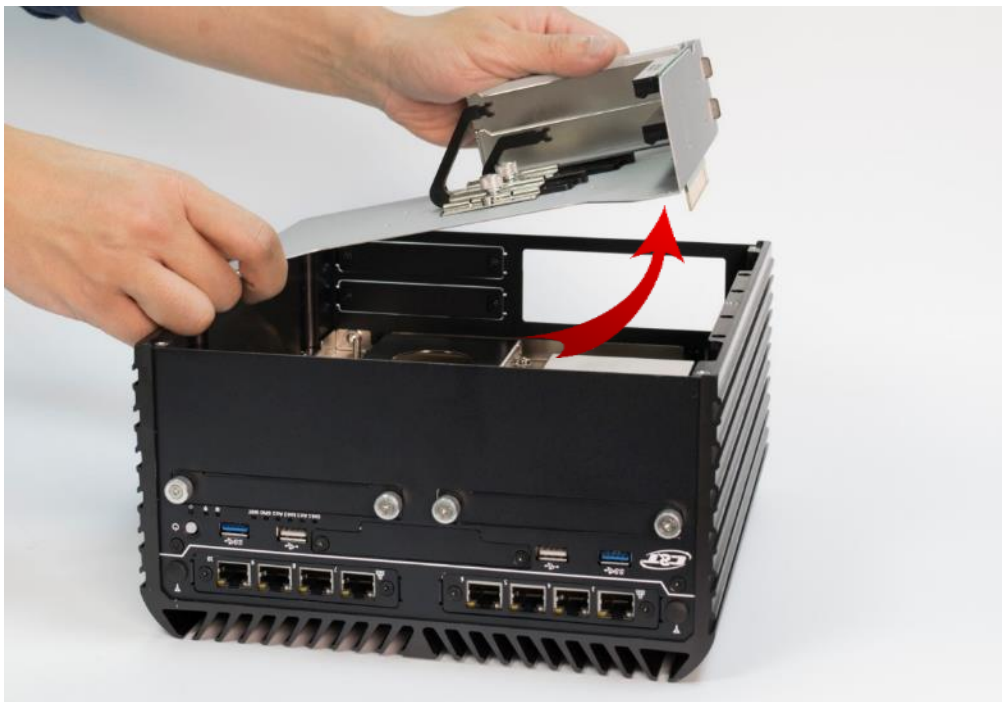

3.4 Removing chassis top cover

1. Unscrew the four screws (M3x5L) highlighted below.

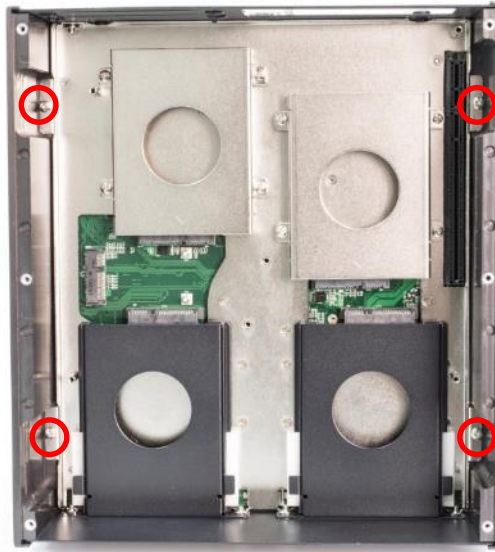

2. Hold the body of the system and lift it vertically away from the top cover.



3. Top cover separated from the system body.



3.5 Installing SODIMM

1. Place the system body with SODIMM socket facing upward. Two SODIMM sockets are available for RCO-6000 Series on the top side.

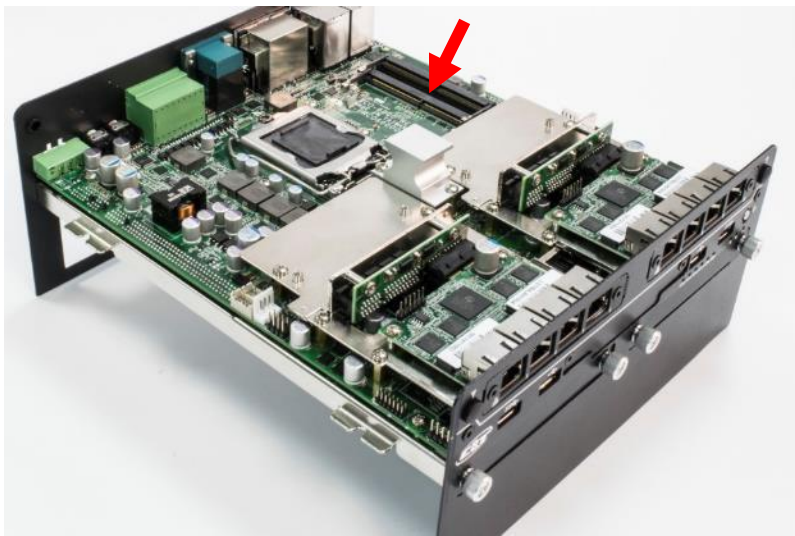

2. Insert memory module from 45 degree direction.

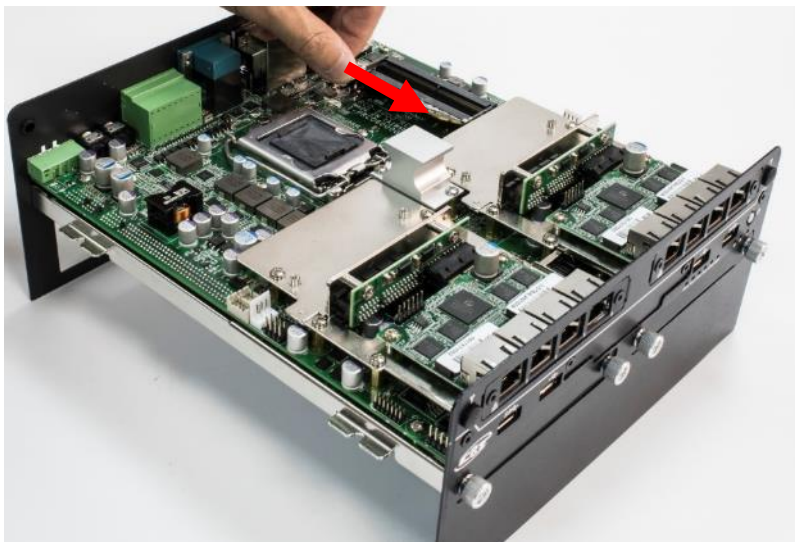

3. Press the memory module vertically downward until you hear the “click” sound. Make sure the memory module is firmly in place.

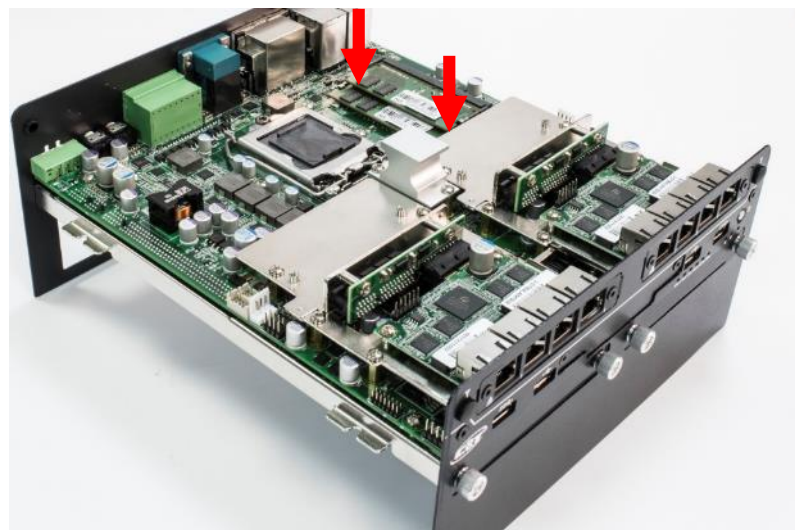

3.6 Installing CPU

1. CPU socket is located on the top side.

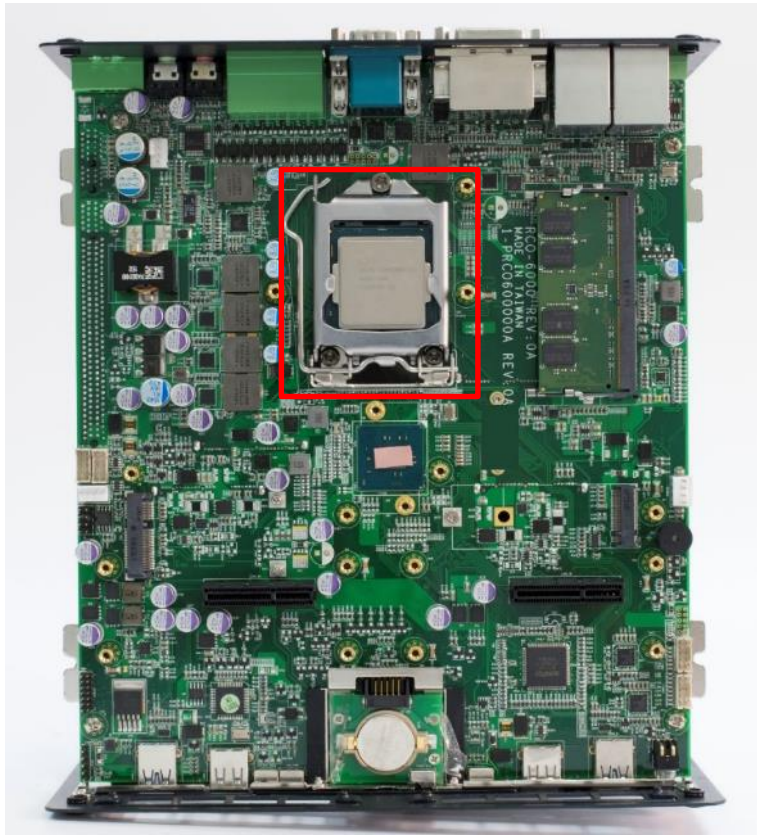

2. Press down the CPU socket lever in order to open the socket cover.

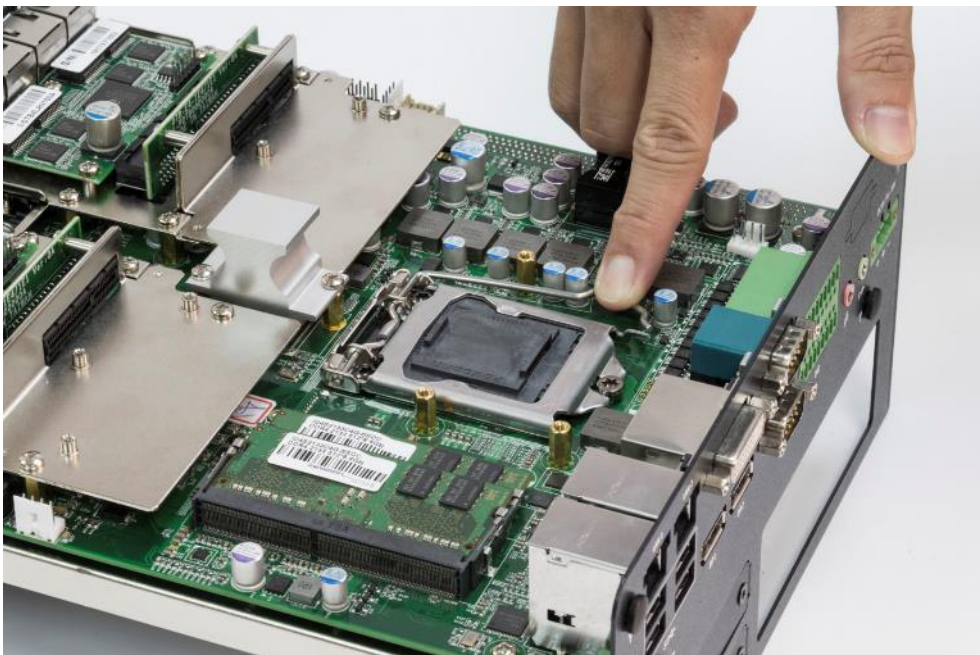

3. Remove the CPU protective cover.

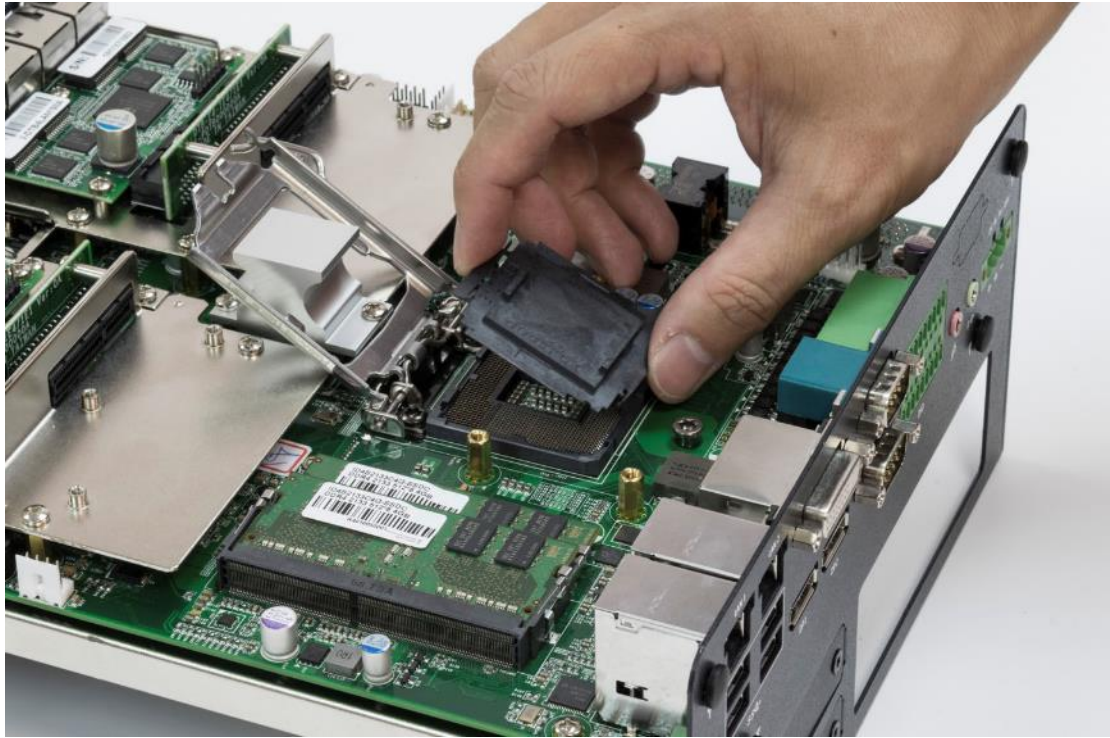

4. Insert CPU gently.

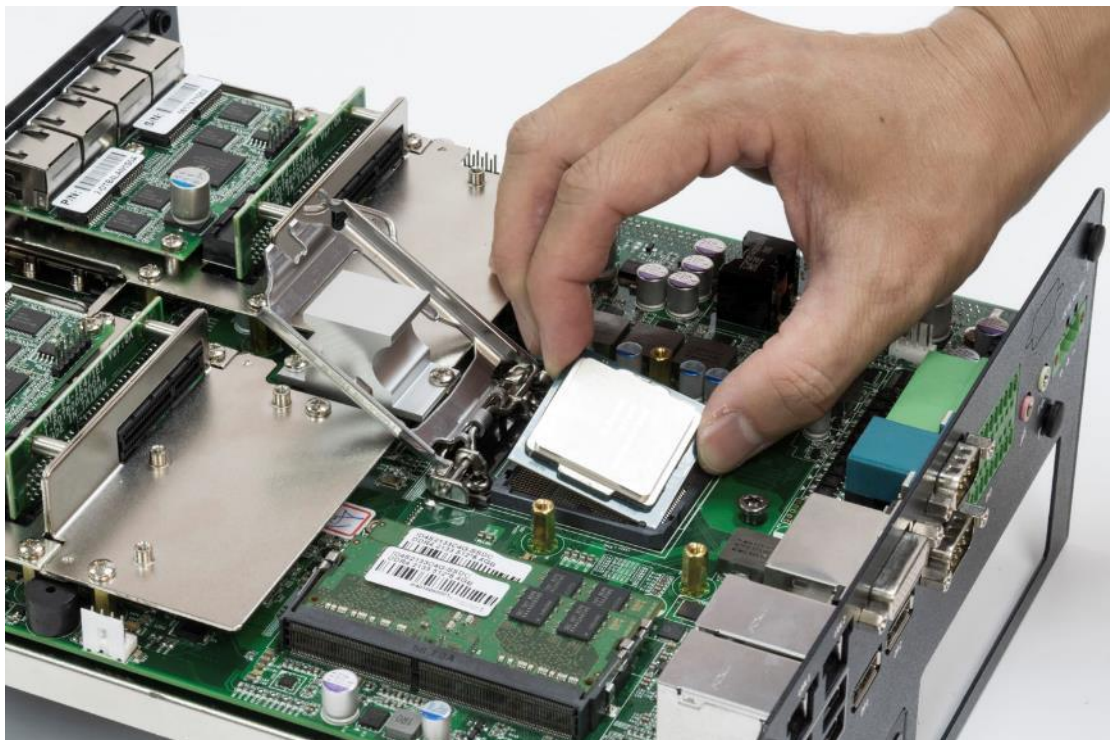

5. Press down the lever again to hold the socket cover.

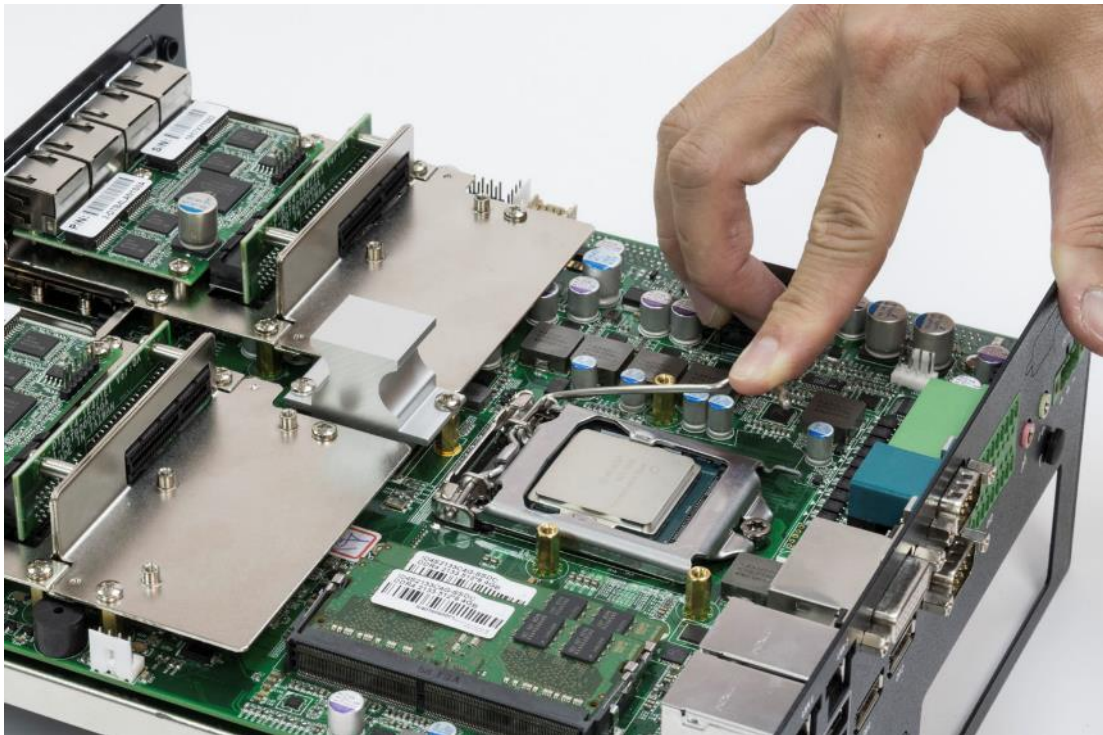

6. Paste thermal pad (1-BR0500040, 29x29x0.5mm) on the CPU.

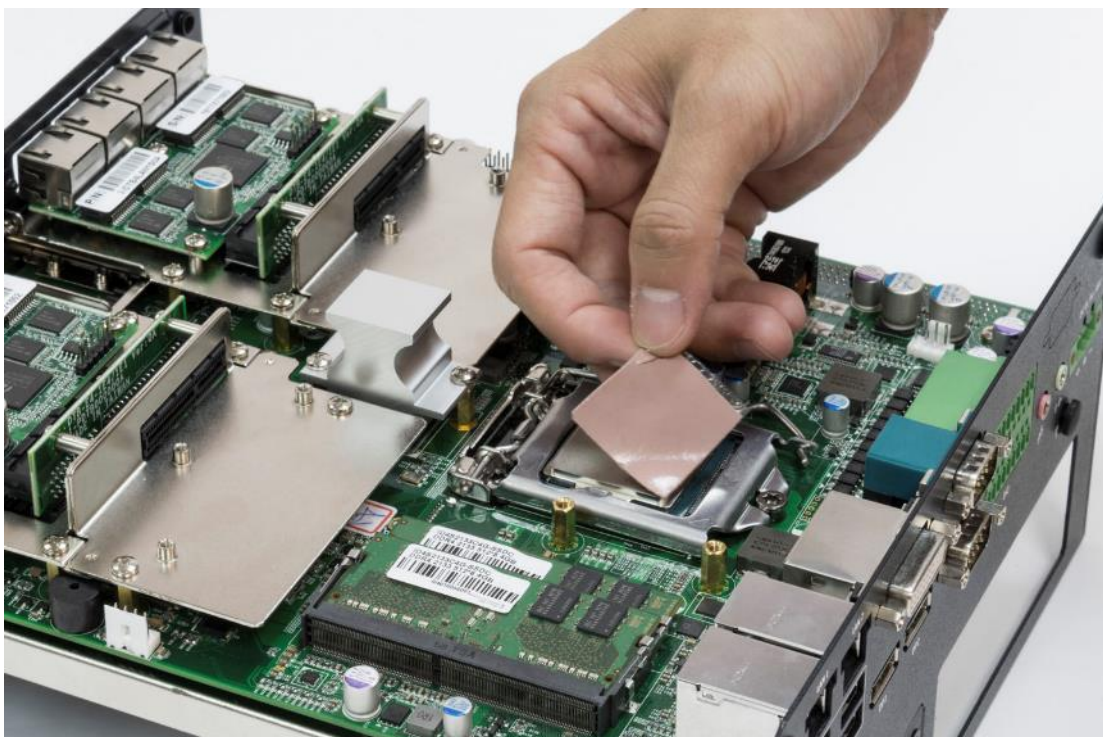

7. Place the designated heat block onto the CPU with thermal pad.

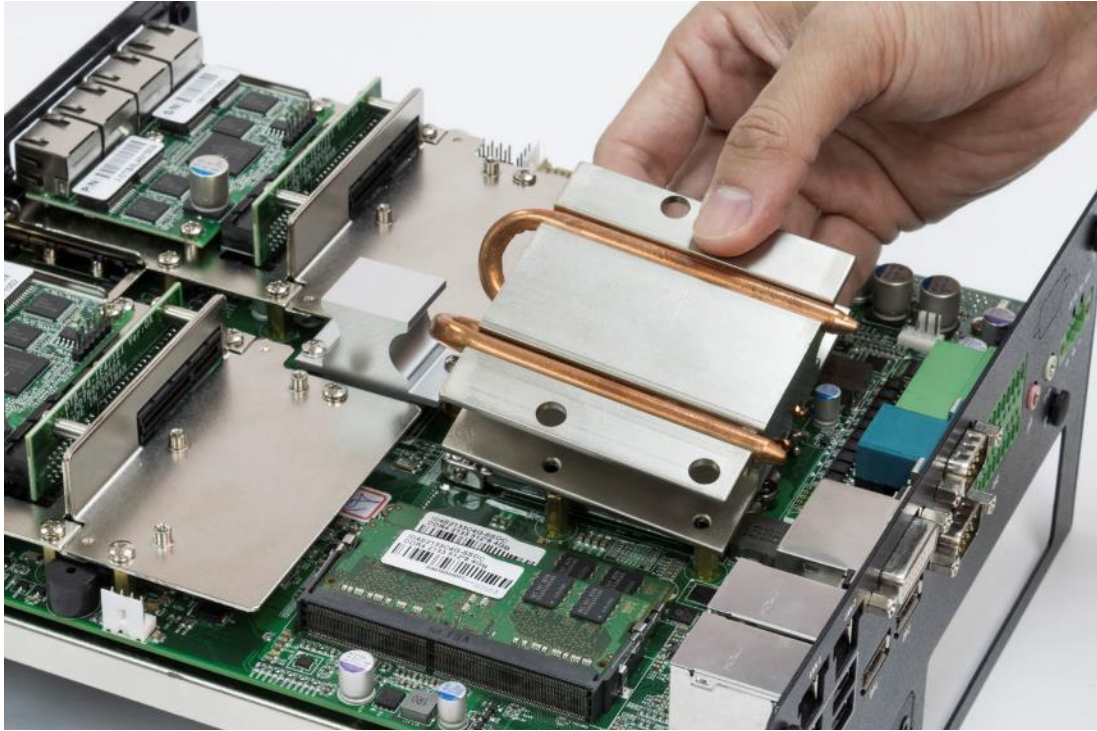

8. Lock the heat block with three screws (M3x5L). Screw driver will be able to penetrate through the holes on the top in order to fasten the screws with copper stud.

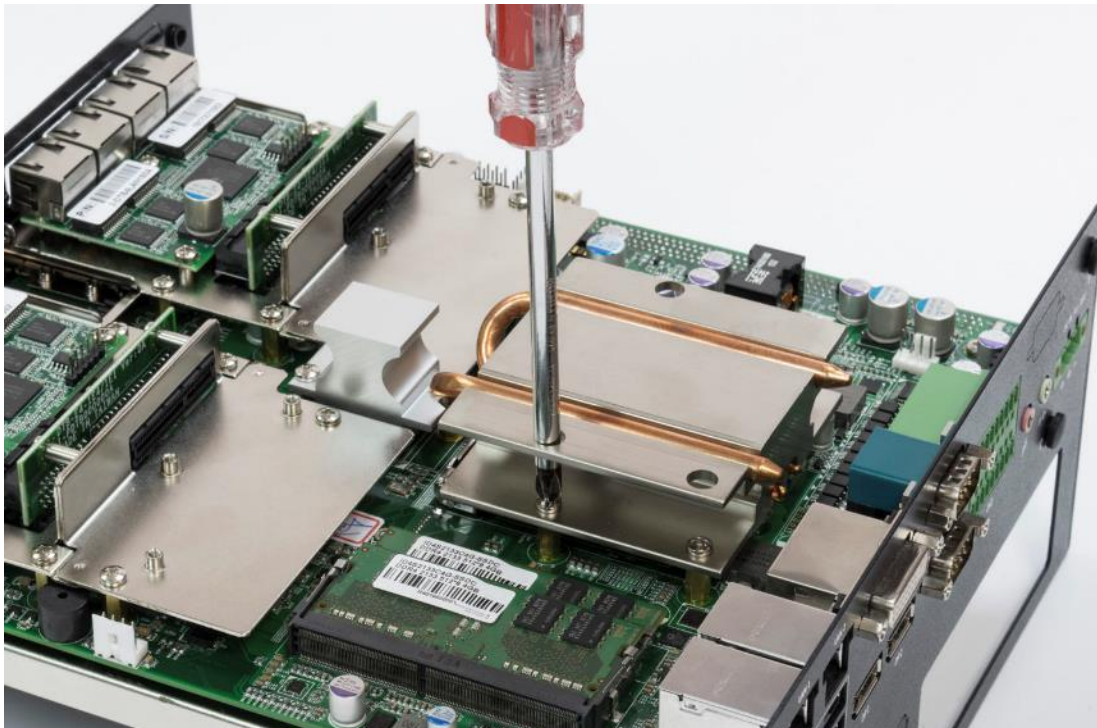

9. Paste the thermal pad (1-BR0500041, 76x70x2.0mm) onto the installed heat block.

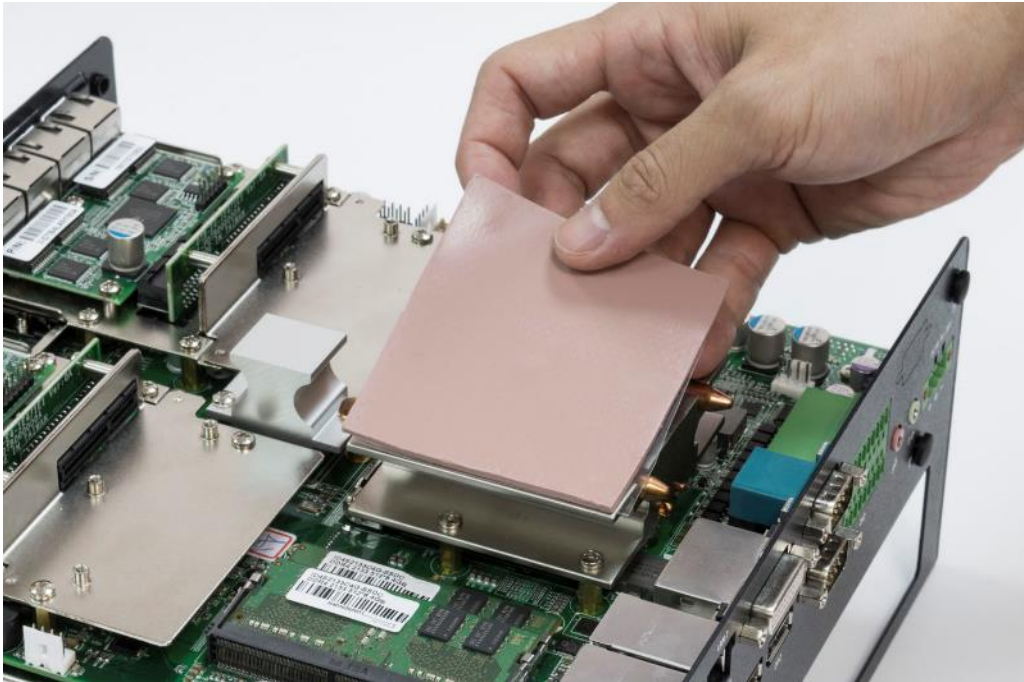

10. Installation complete.



3.7 Installing mini PCIe card / mSATA

1. Four mini PCIe slots are available for RCO-6000 series, three on top side and one on bottom side. CN3 and CN4 on the top side support mSATA.

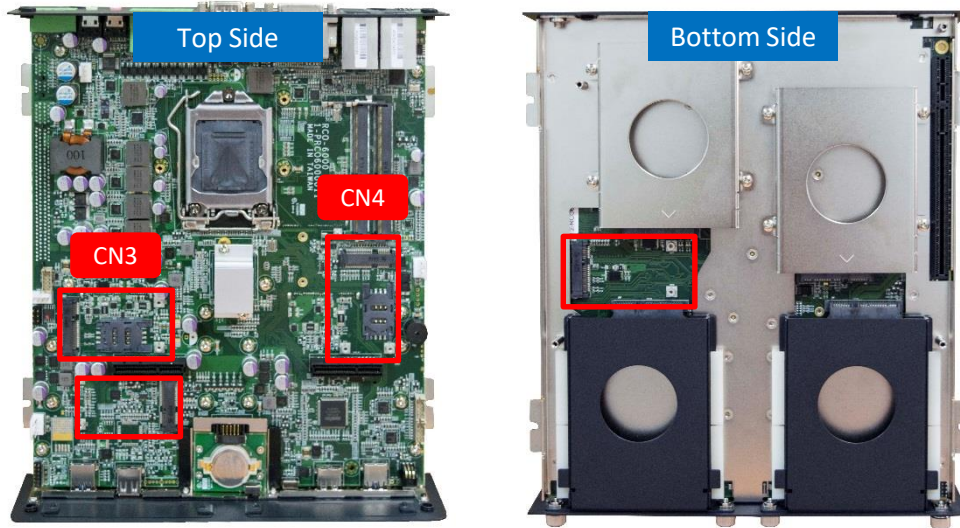

2. Insert mini PCIe card from 45 degree direction.

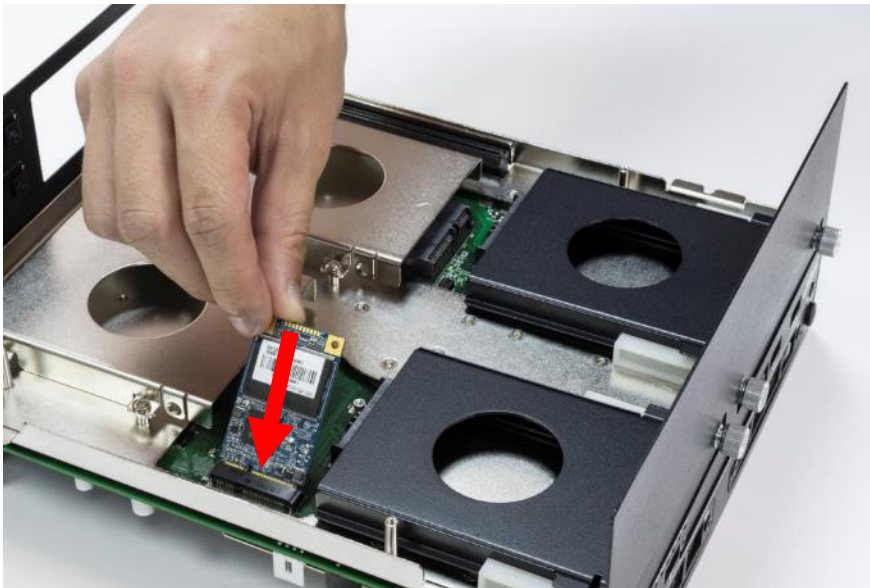

3. Press the mini PCIe card down and lock it with two screws (M2x3.7L).



3.8 Installing antenna

1. Four antenna holes are available for RCO-6000 series on the rear panel and two holes are on the front panel.

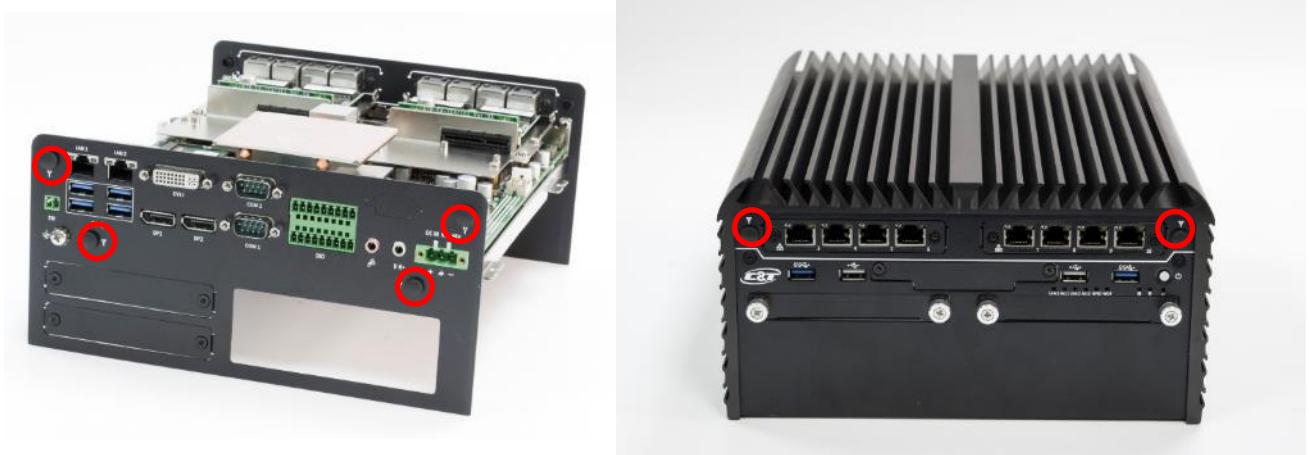

2. Remove antenna hole cover on the system panel.



3. Have antenna jack penetrate through the hole.



- Put on washer and fasten the nut with antenna jack.



- Assemble the antenna and antenna jack together.



- Attach the RF connector at the cable-end onto the communication module.

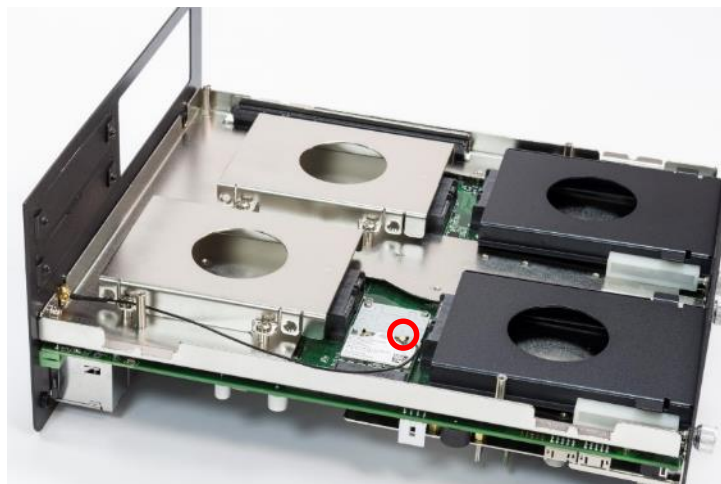

3.9 Assembly chassis top cover

1. Place the top cover upside down as shown below.



2. Ensure thermal pad is in place on both the CPU thermal block and PCH thermal block.

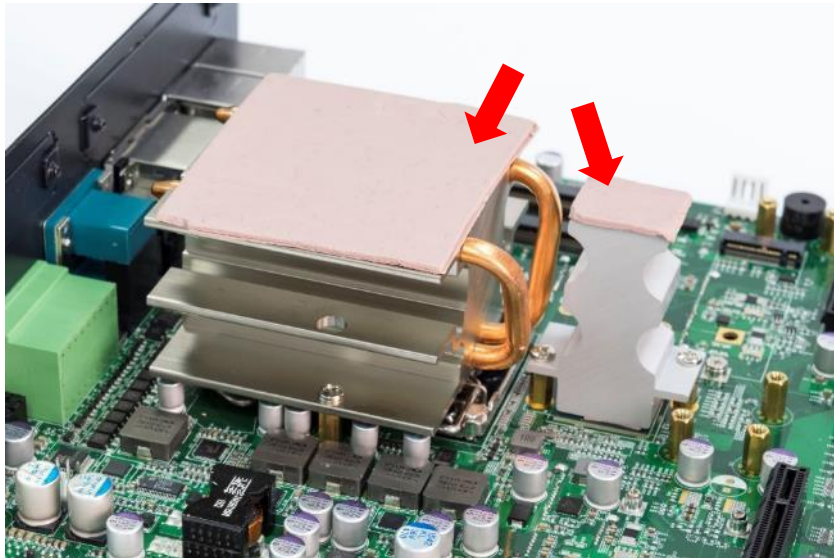

3. Hold the system body and slide the front/rear panel into the slide rail on the top cover.

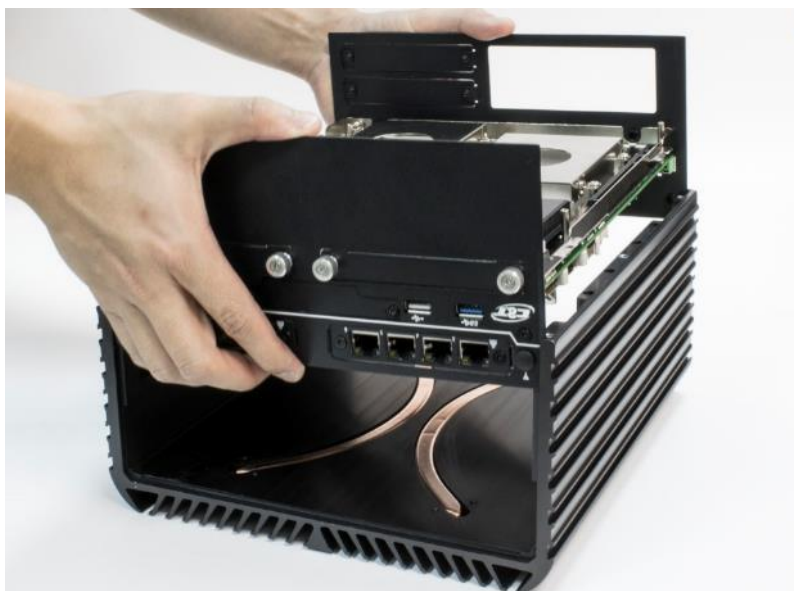

4. Push the system body down until it is firmly in place.



5. Fasten the four screws (M3x5L) to lock the system body with top cover.

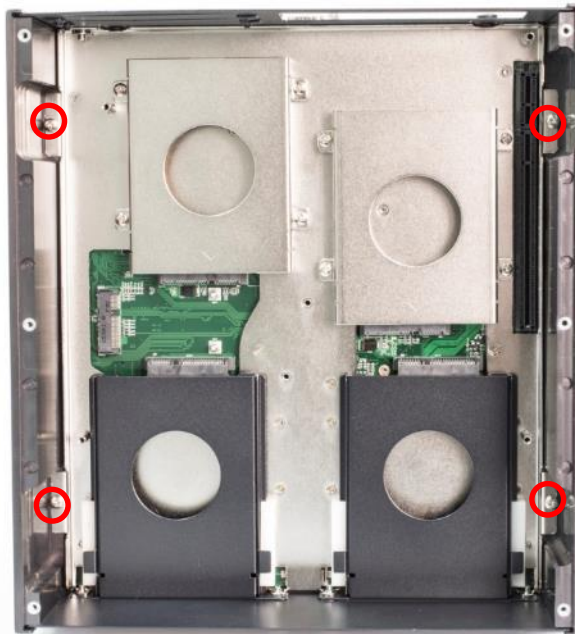

3.10 Installing HDD on internal SATA HDD bay

1. Two internal SATA HDD bays are available for RCO-6000 series.

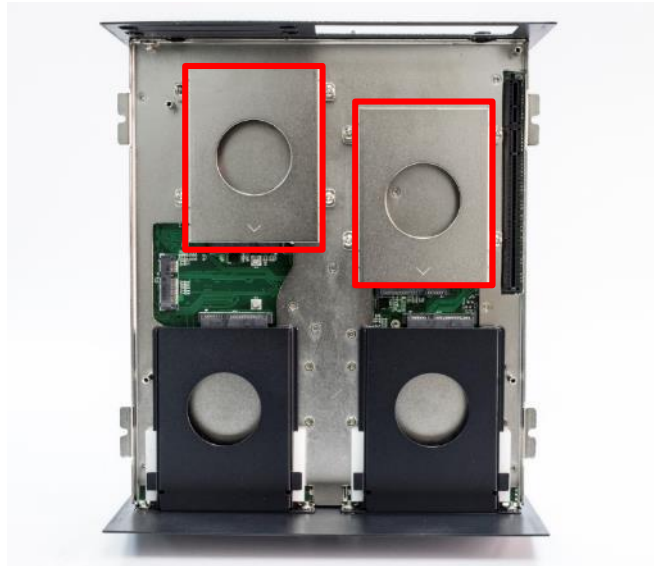

2. Unscrew the four screws (M3x5L) to remove the internal SATA HDD bay.

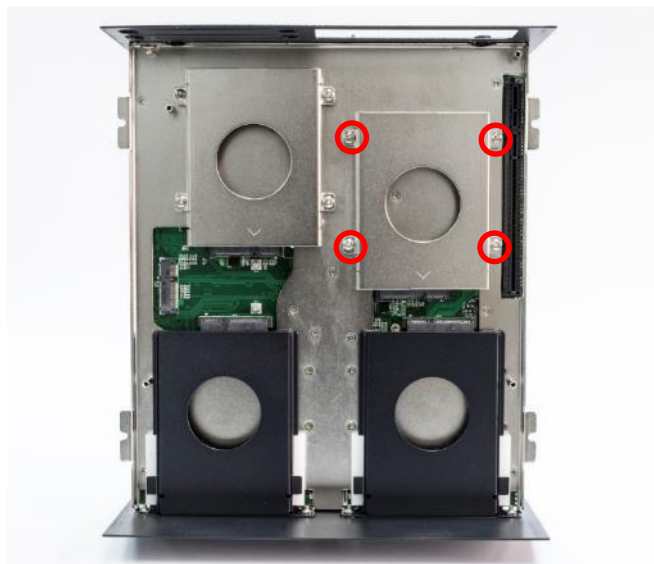

3. Lock the 2.5" HDD with HDD bracket using four screws (M3x4L).

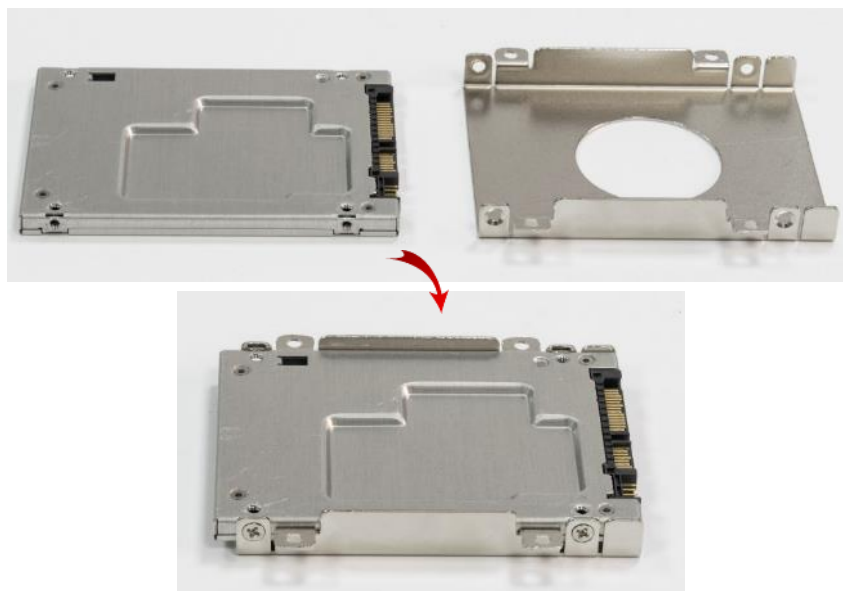

4. Install the HDD bracket following the direction below.

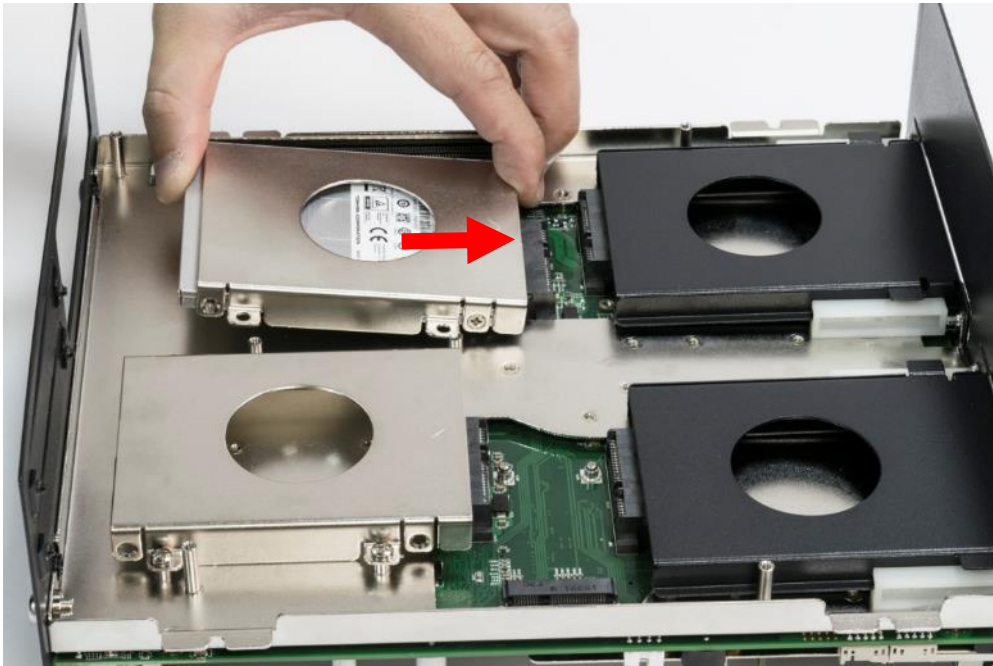

5. Fasten the four screws to lock the internal HDD bracket.



3.11 Installing HDD on removable SATA HDD bay

1. Two removable SATA HDD bays are available for RCO-6000 Series.
2. Unscrew the two sun screws circled below to take out the removable SATA HDD bay.



3. Lock the 2.5" HDD with HDD bracket using four screws (M3x4L).

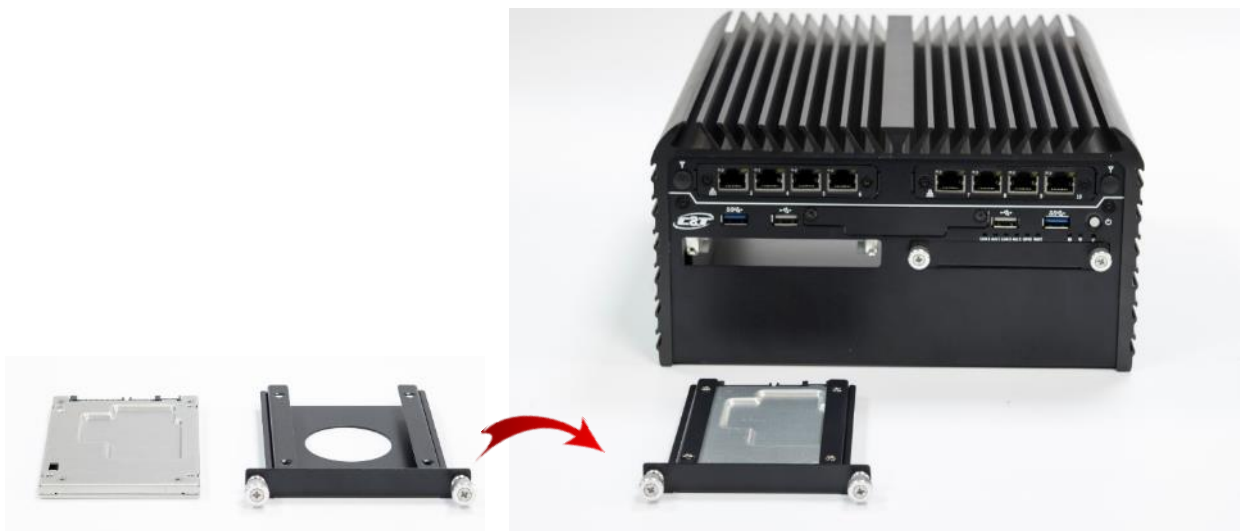

4. Slide the HDD bracket back and then fasten the sun screws.



3.12 Installing PCIe/PCI expansion card

1. PCIe or PCI card with FHHL dimension is supported by RCO-6000 series.
2. Unscrew the screw (M3x5L) to remove the plane bracket.

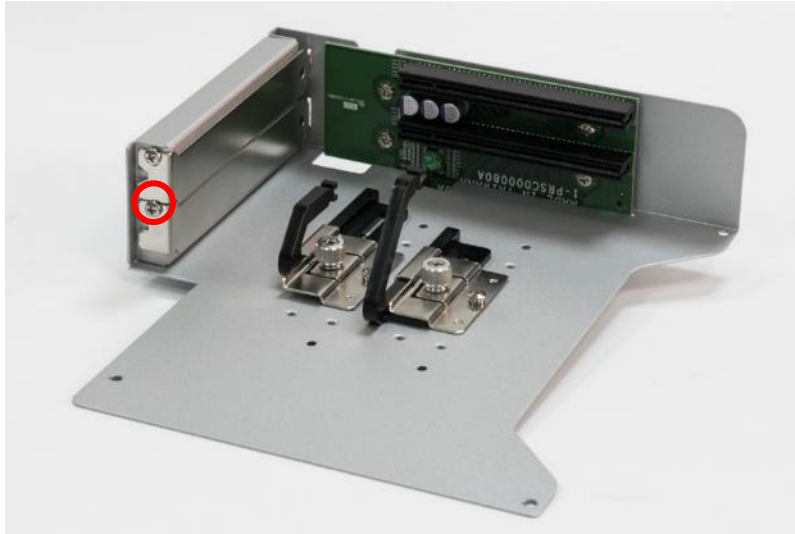

3. Loosen the sun screw (circled below) on the holder so the pairing arm can be adjustable.



4. Install the PCIe/PCI card according to the below direction and ensure the gold finger is inserted into the slot. Then fasten the screw in the circle.



5. Adjust the arm until it holds the card firmly in place. Then fasten the sun screw on the holder.

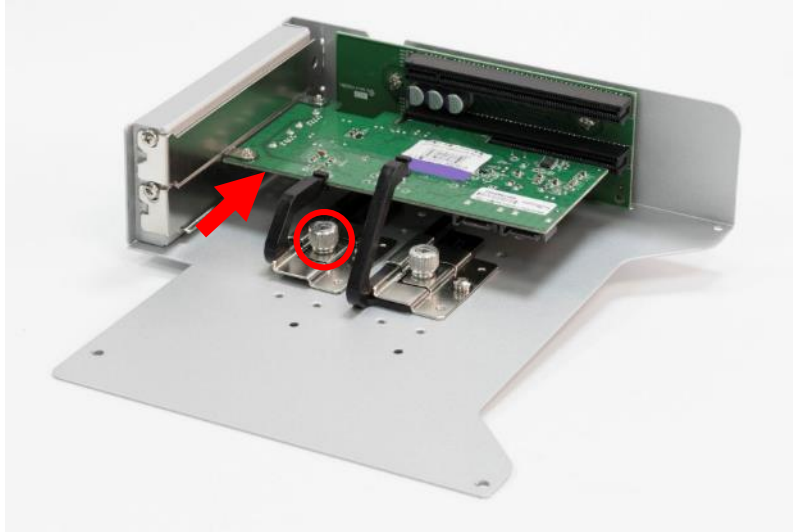

6. For RCO-6022 series, which has two expansion slots, follow the same procedure to install the second card.



7. For easier installation, install the upper card (Card 1) first and then install the lower card (Card 2).

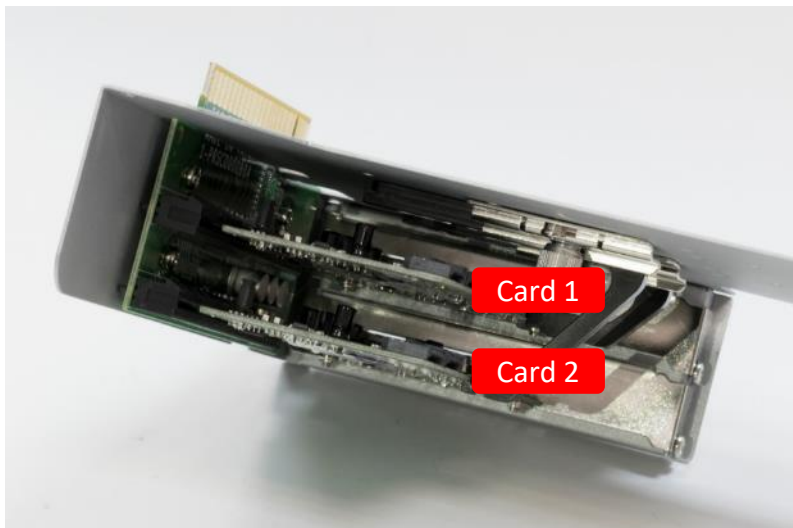

3.13 Assemble PCIe/PCI expansion module

1. Install the expansion module back in place and ensure the golden finger is inserted into the expansion slot.



2. Fasten the four screws (M3x5L) below to lock the expansion module.



3.14 Assemble chassis bottom cover

1. Place the bottom cover according to the below direction and make sure the rail is facing inside the system.

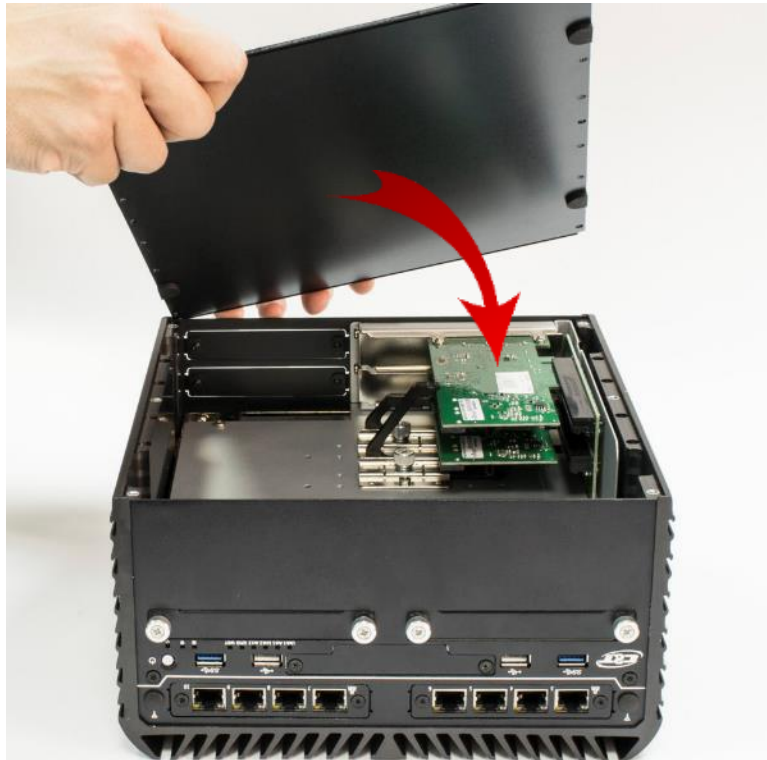

2. Lock the bottom cover with the six screws (M3x5L).



3.15 Installing SIM card

1. For RCO-6000 Series, SIM card slot is located inside the control area. Unscrew the two screws below to remove the cover bracket.



2. Now you can insert SIM card into the socket.



3. Please note that the installation of SIM cards has to match the installation of mini PCIe slots.

SIM Card Socket Number	Matching Mini PCIe Slot
SIM 1	MINIPCE1
SIM 2	MINIPCE2
SIM 3	CN3
SIM 4	CN4

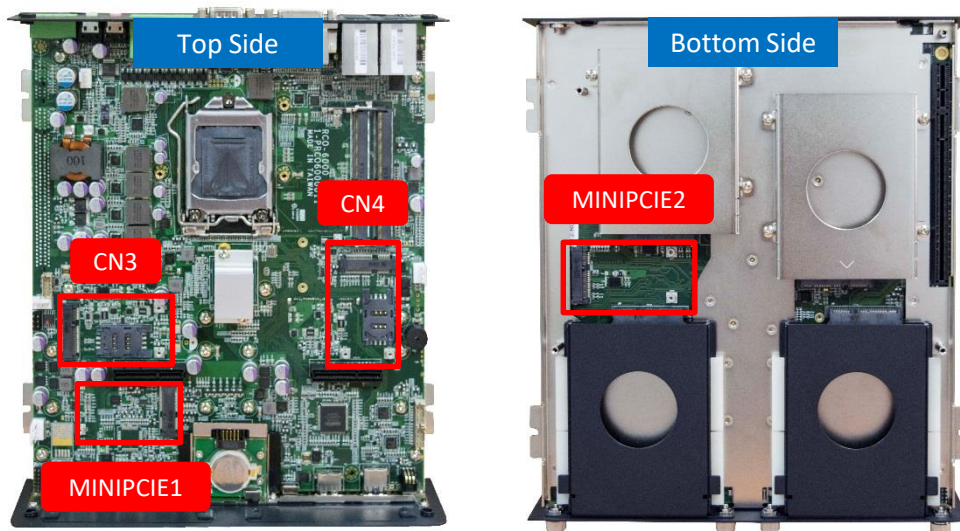

4. To uninstall SIM card, simply press the installed SIM card and then the card will be pushed out.

3.16 Installing wall mount kit

1. Wall mount kit is available for RCO-6000 series included in the standard package.



2. Place the system upside down so you can see the bottom cover. The highlighted eight screw holes below will be used.



3. Lock the wall mount kit with eight screws (M3x5L, Nylok).



Chapter 4

BIOS Setup

4.1 BIOS Introduction

The system BIOS software is stored on EEPROM. The BIOS provides an interface to modify the configuration. When the battery is removed, all the parameters will be reset.

BIOS Setup

Power on the embedded system and by pressing or <F2> immediately allows you to enter the setup screens. If the message disappears before you respond and you still wish to enter the Setup, restart the system by turning it OFF and ON or pressing the RESET button.

You may also restart the system by simultaneously pressing <Ctrl>, <Alt>, and <Delete> keys.

Control Keys	
<←> <→>	Select Screen
<↑> <↓>	Select Item
<Enter>	Select
<Page Up/+>	Increases the numeric value or makes changes
<Page Down/->	Decreases the numeric value or makes changes
<F1>	General Help
<F2>	Previous Value
<F3>	Load Optimized Defaults
<F4>	Save Configuration and Exit
<Tab>	Select Setup Fields
<Esc>	Exit BIOS Setup

Main Setup

The main menu lists the setup functions you can make changes to. You can use the arrow keys (↑ ↓) to select the item. The on-line description of the highlighted setup function is displayed at the bottom of the screen.

General Help <F1>

The BIOS setup program provides a General Help screen. You can call up this screen from any menu by simply pressing <F1>. The Help screen lists the appropriate keys to use and the possible selections for the highlighted item. Press <Esc> to exit the Help screen.

4.2 Main Setup

Press to enter BIOS CMOS Setup Utility, the Main Menu (as shown below) will appear on the screen. Use arrow keys to move among the items and press <Enter> to accept or enter a sub-menu.



■ System Language

Language setup allows the user to configure the language. Please use <Tab> to switch between language elements.

■ System Date

Set the date. Please use <Tab> to switch between date elements.

■ System Time

Set the time. Please use <Tab> to switch between time elements.

4.3 Advanced Setup

This section allows you to configure and improve your system and allows you to set up some system features according to your preference.

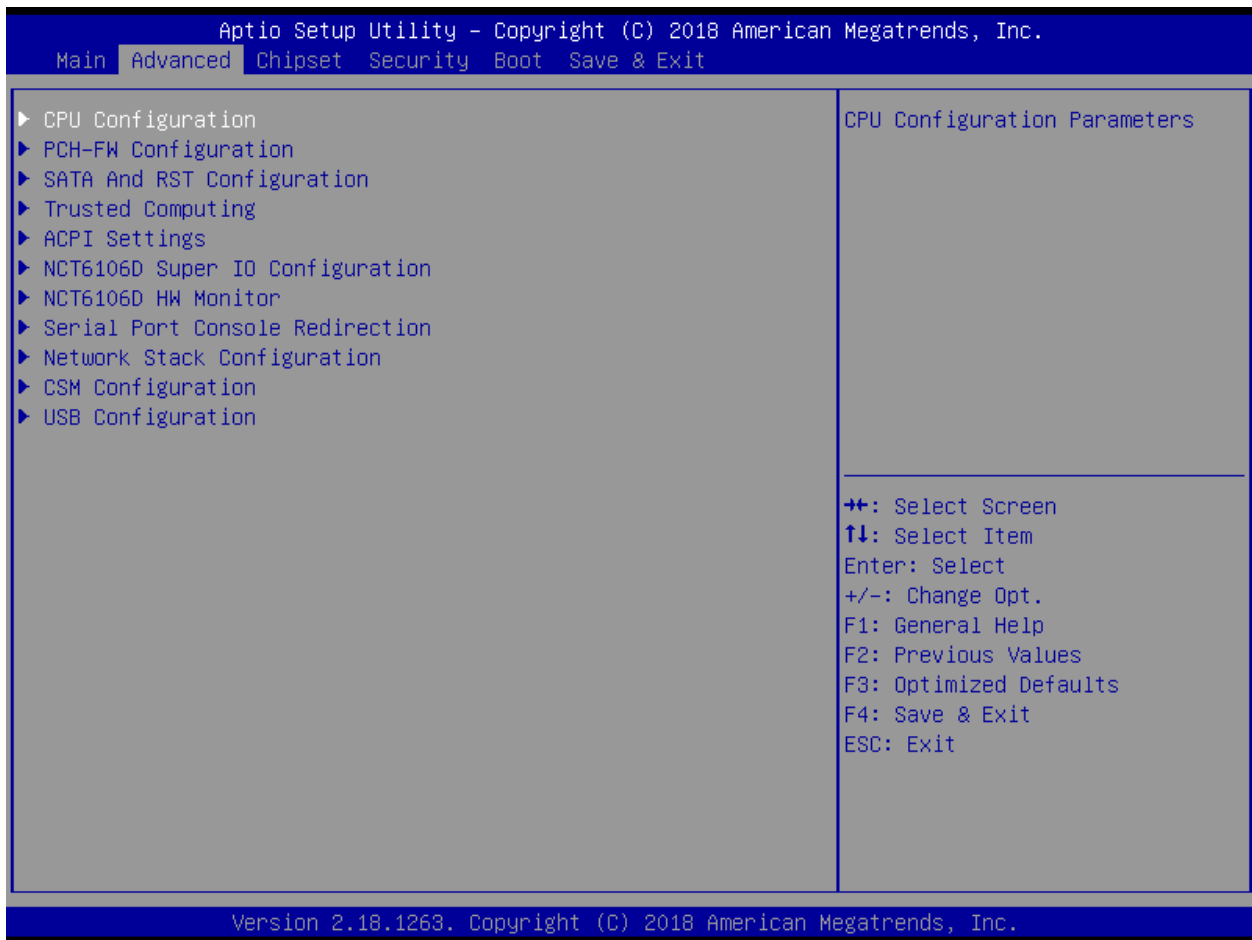

4.3.1 CPU Configuration

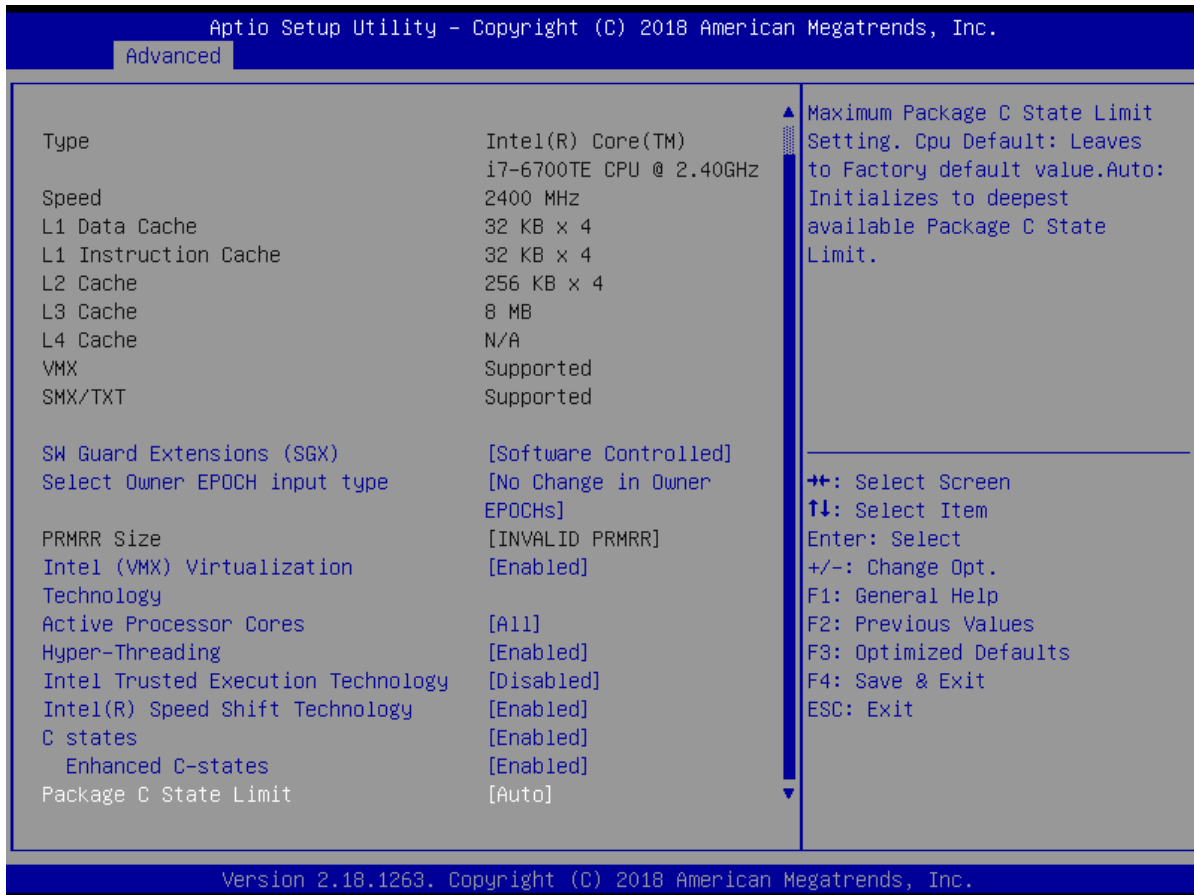

■ SW Guard Extensions (SGX)

This item allows you to set the SW Guard Extensions.

■ Select Owner EPOCH input type

This item allows you to select the owner EPOCH input type.

■ PRMRR Size

This item allows you to set the PRMRR Size.

■ Intel (VMX) Virtualization Technology

When enabled, a VMM can utilize the integrated hardware virtualization support.

■ Active Processor Cores

Set number of cores to be enabled. Select <All> or <1> mode.

■ Hyper-Threading

This item allows you to enable or disable the Intel Hyper-Threading Technology.

■ Intel Trusted Execution Technology

This item allows you to enable or disable the Intel Trusted Execution Technology.

■ Intel(R) Speed Shift Technology

This item allows you to enable or disable the Intel Speed Shift Technology

■ CPU C states

This item allows you to set the power saving of the CPU states.

Enhanced C State

This item allows your CPU reduce power consumption

■ Package C State limit

Select Auto for the AMI BIOS to automatically set the limit on the C-State package register. The options are C0/ C1, C2, C3, C6, C7, C7s, C8 and No Limit.

4.3.2 PCH-FW Configuration

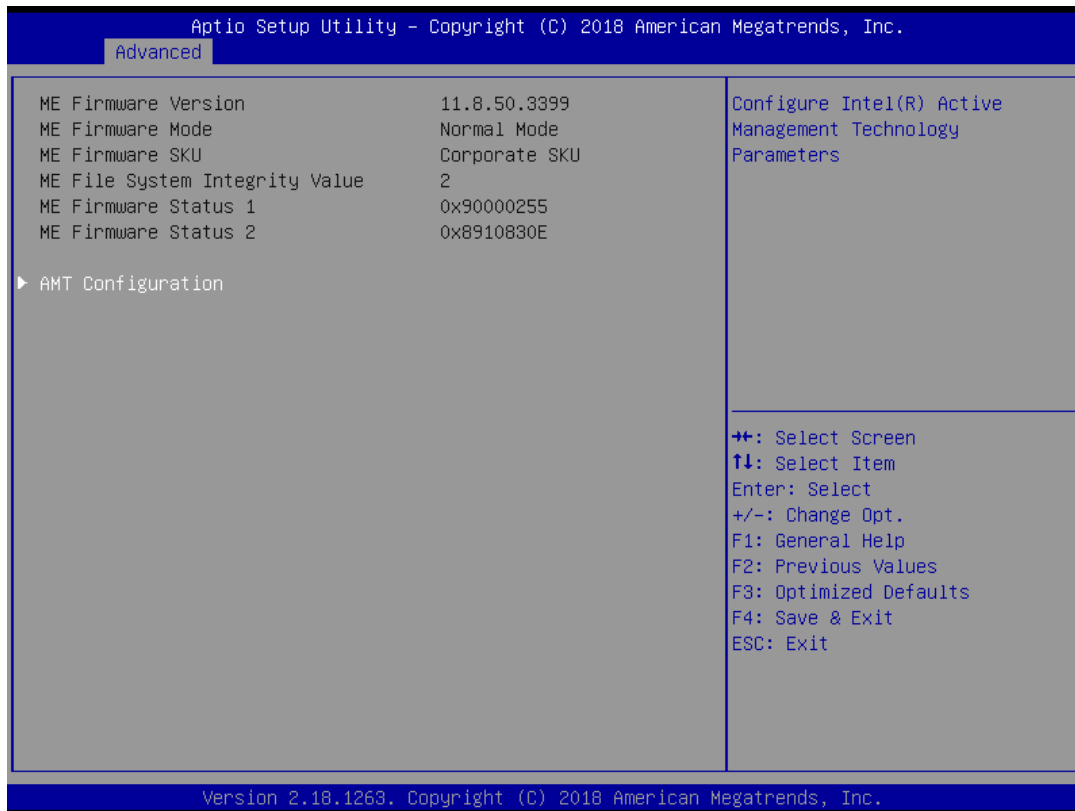

■ AMT Configuration

Intel Active Management Technology (AMT) is hardware-based technology for remotely managing and securing PCs out-of-band.

■ Un-Configure ME

Use this function to enable or disable Un-Configure ME without password function.

4.3.3 SATA And RST Configuration

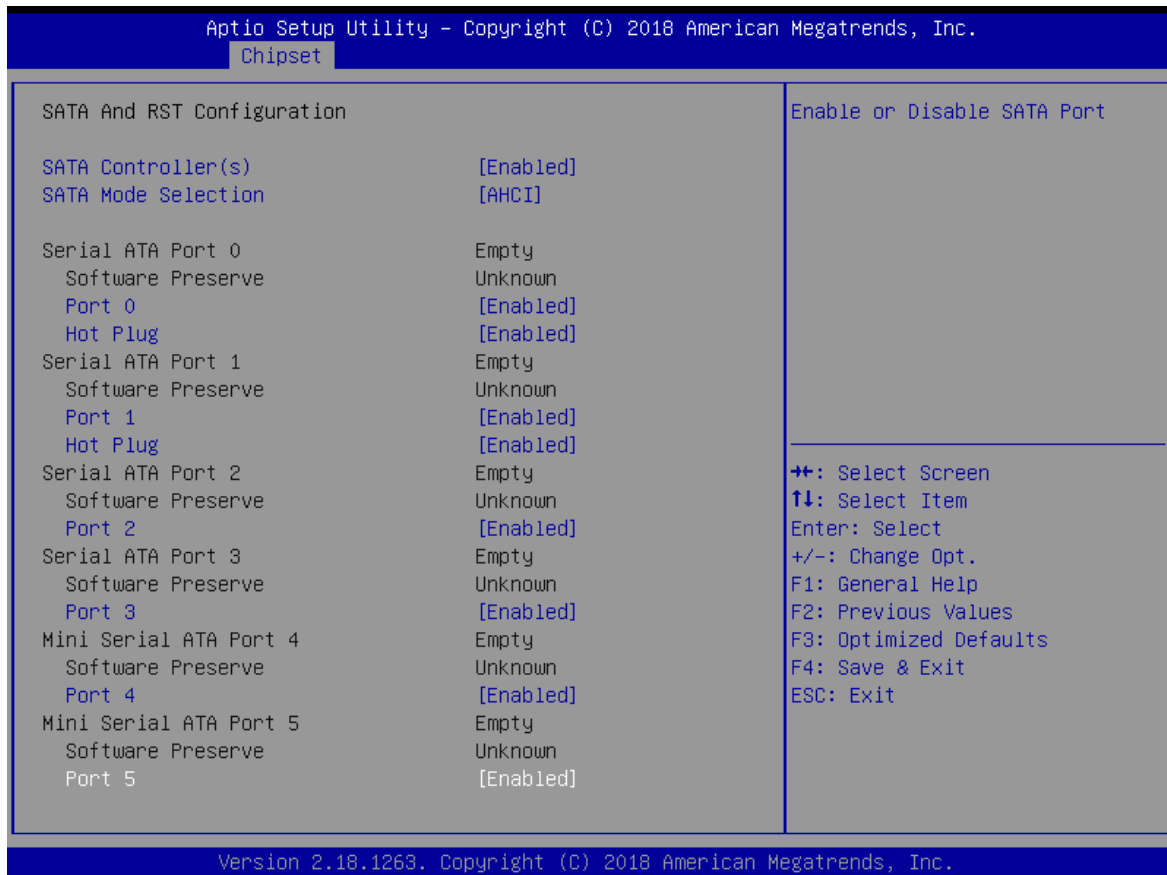

■ SATA Controller(s)

Enable or disable Serial ATA controller.

■ SATA Mode Selection

This item allows users to select mode of SATA controller.

■ Serial ATA Port 0 / 1 / 2 / 3 / 4 / 5

This item allows users to enable or disable Serial ATA Port 0 / 1 / 2 / 3 / 4 / 5.

4.3.4 RST (UEFI RAID) Configuration

How to set the UEFI RAID:

1. When set to RAID, please save change reset system.

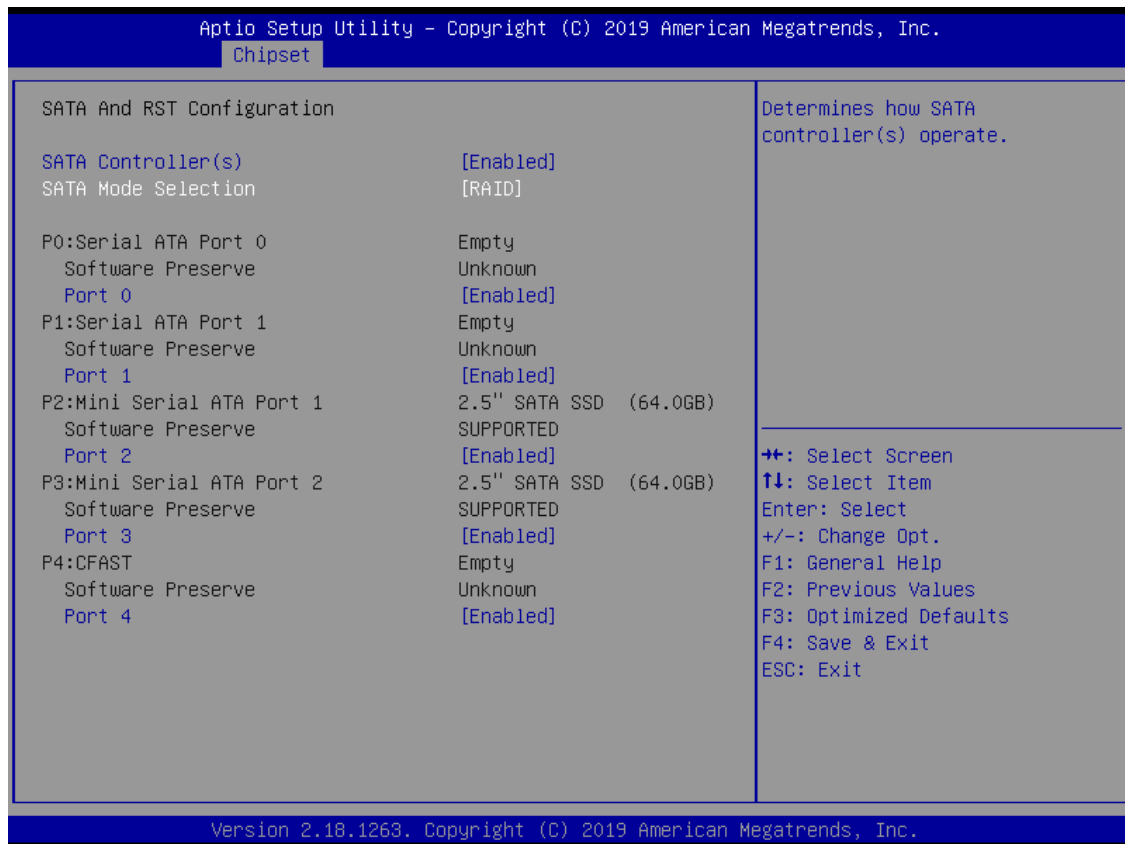

2. After reboot the system, please into BIOS utility and then will see "Intel (R) Rapid Storage Technology"

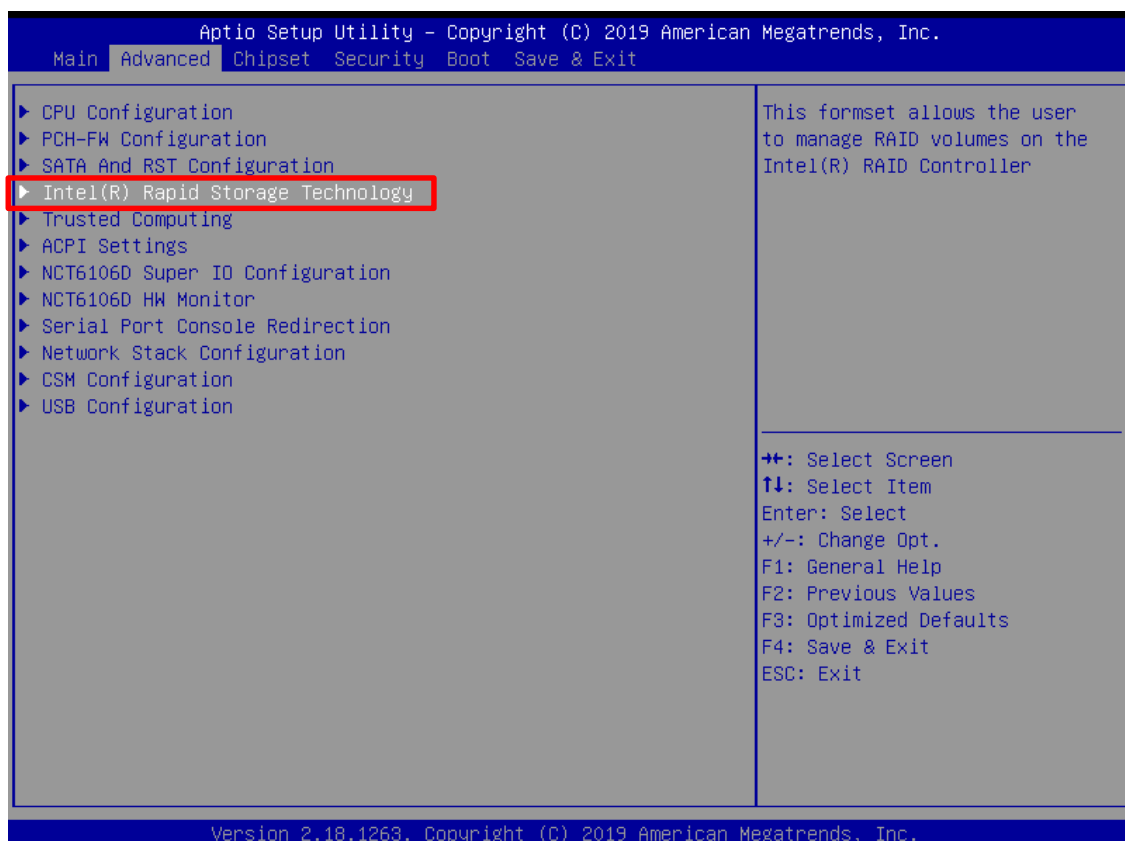

3. Into Intel(R) Rapid Storage Technology, and start create RAID volume.

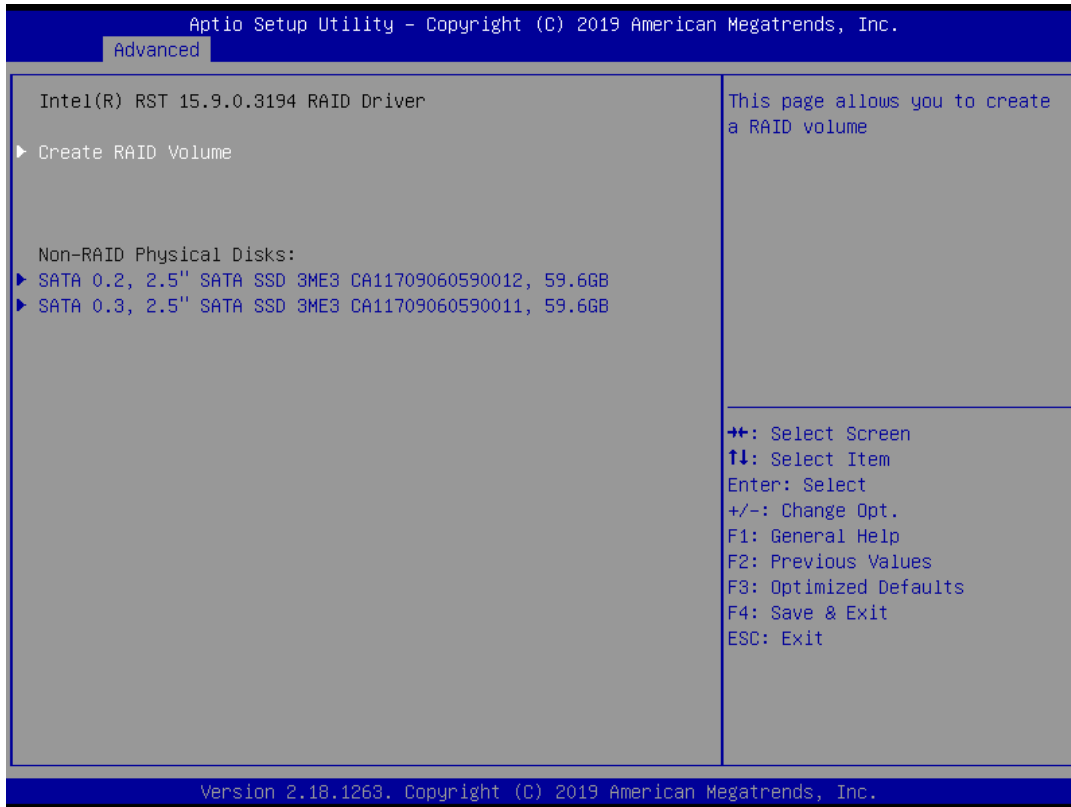

4. Start Create the RAID

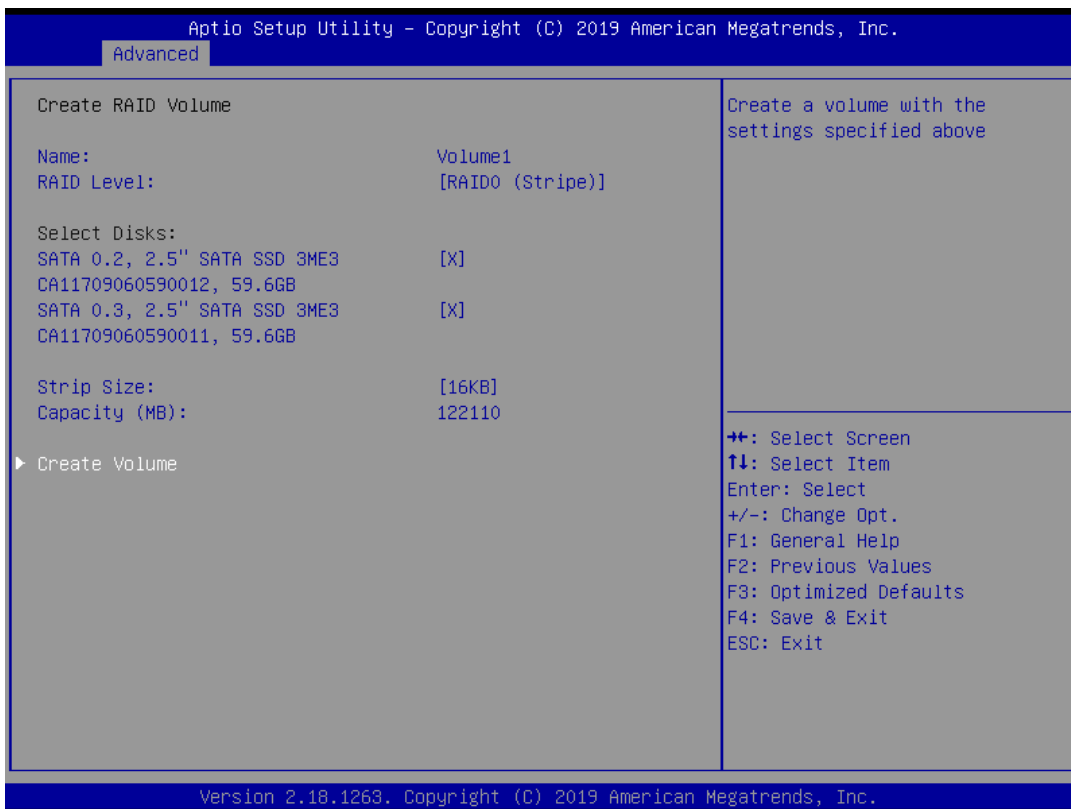

- Select Disk that you want to do the RAID
- Select [x]; No-Select []

4.3.5 Trusted Computing

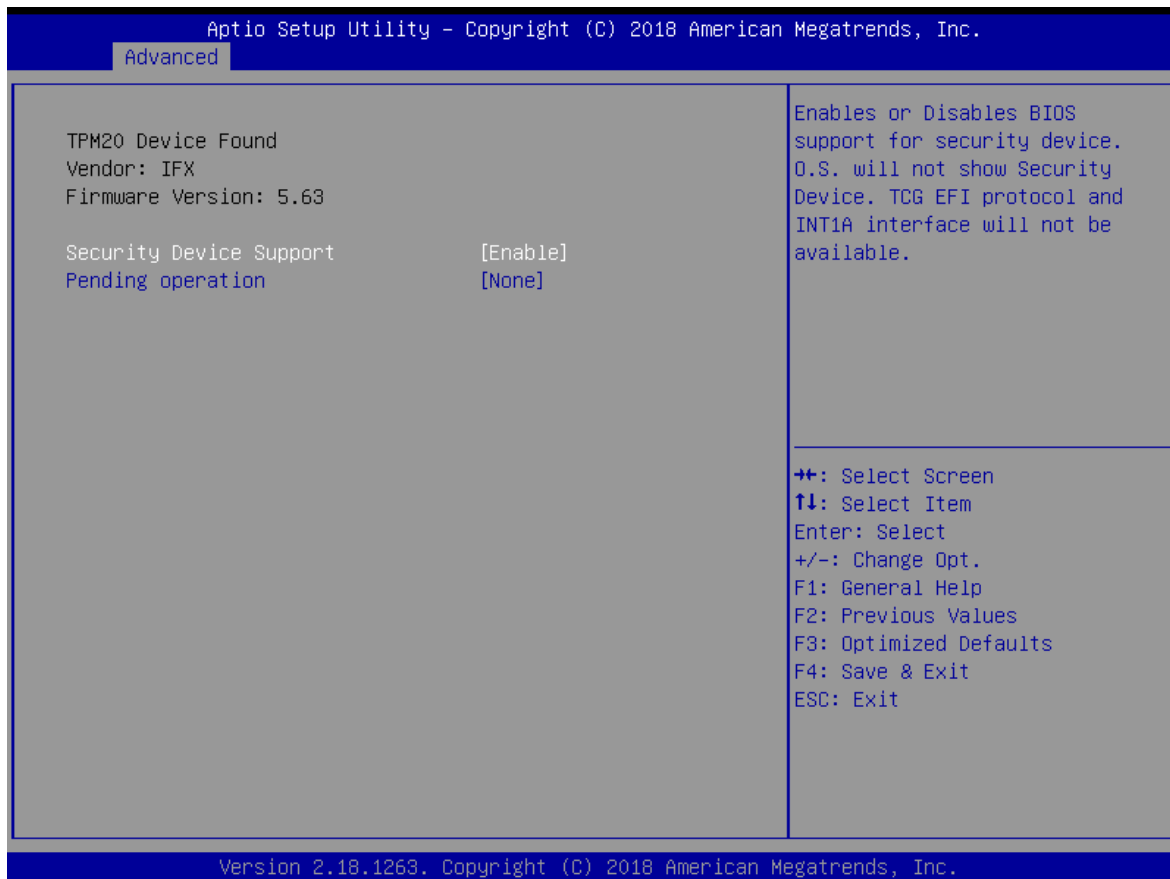

4.3.6 ACPI Settings

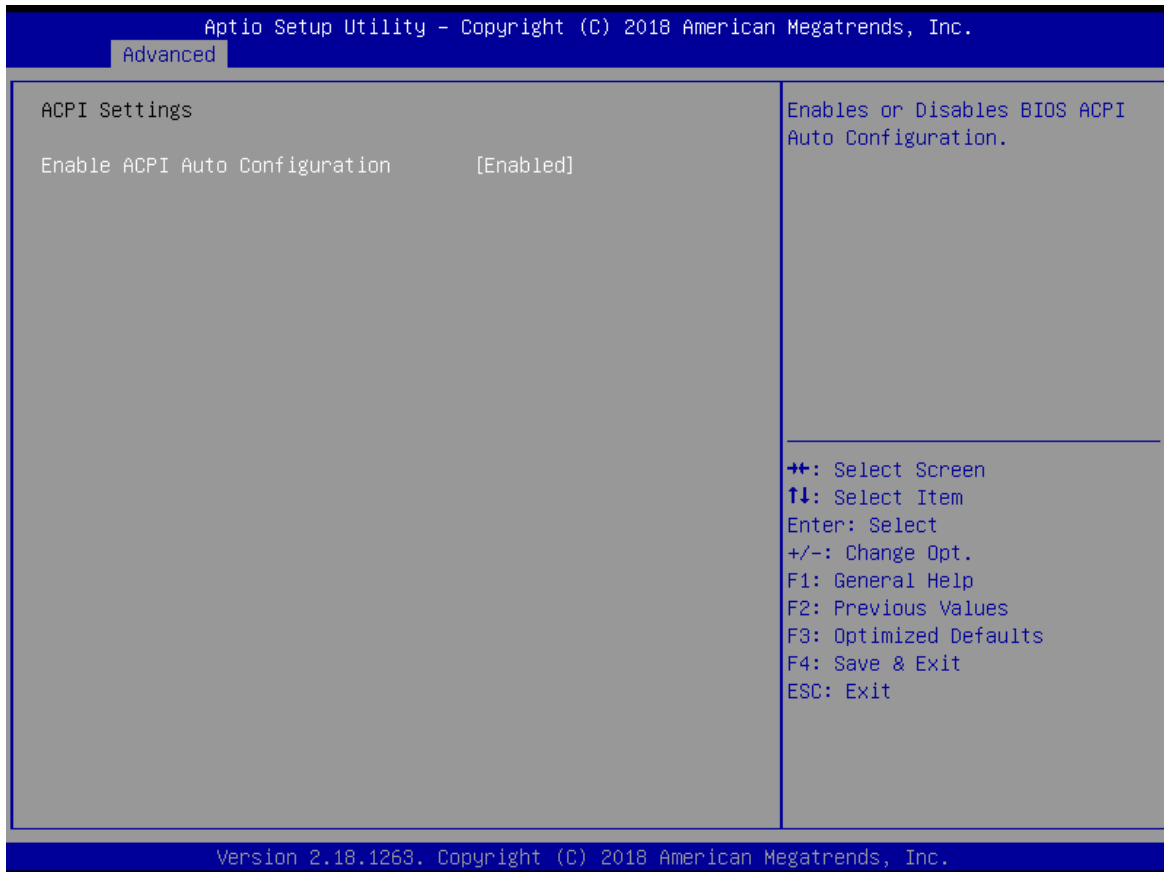

■ Enable ACPI Auto Configuration

Enable or disable BIOS ACPI auto configuration.

4.3.7 NCT6106D Super IO Configuration

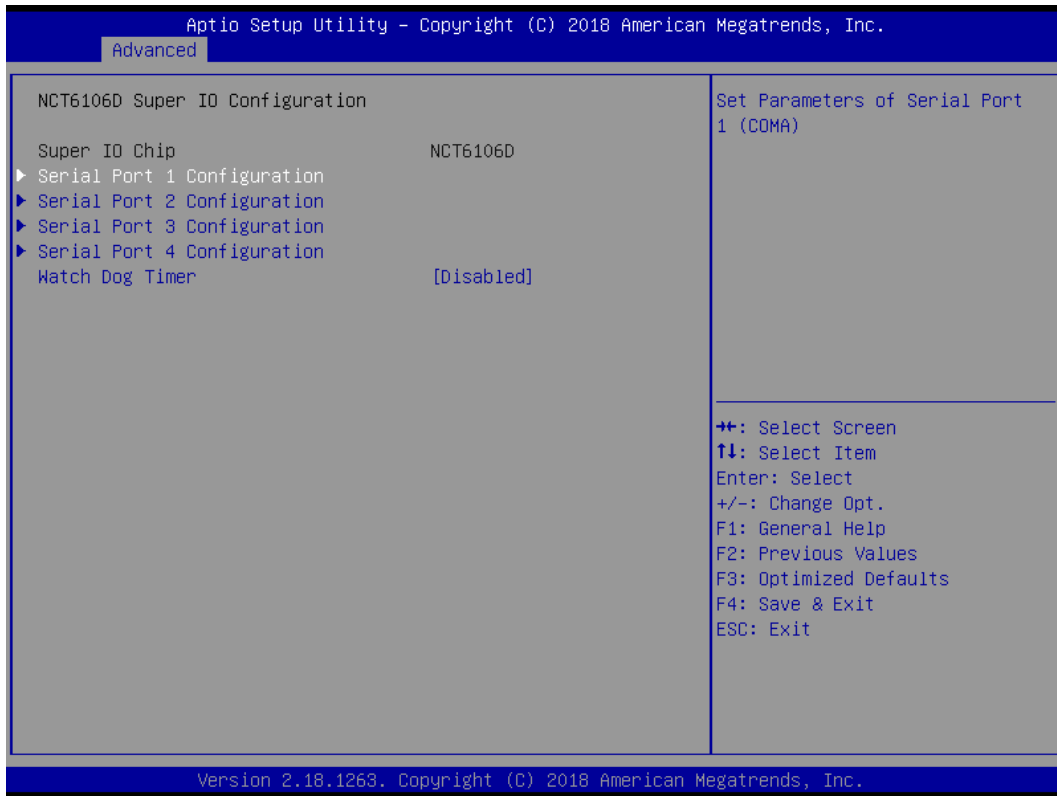

Serial Port 1 Configuration

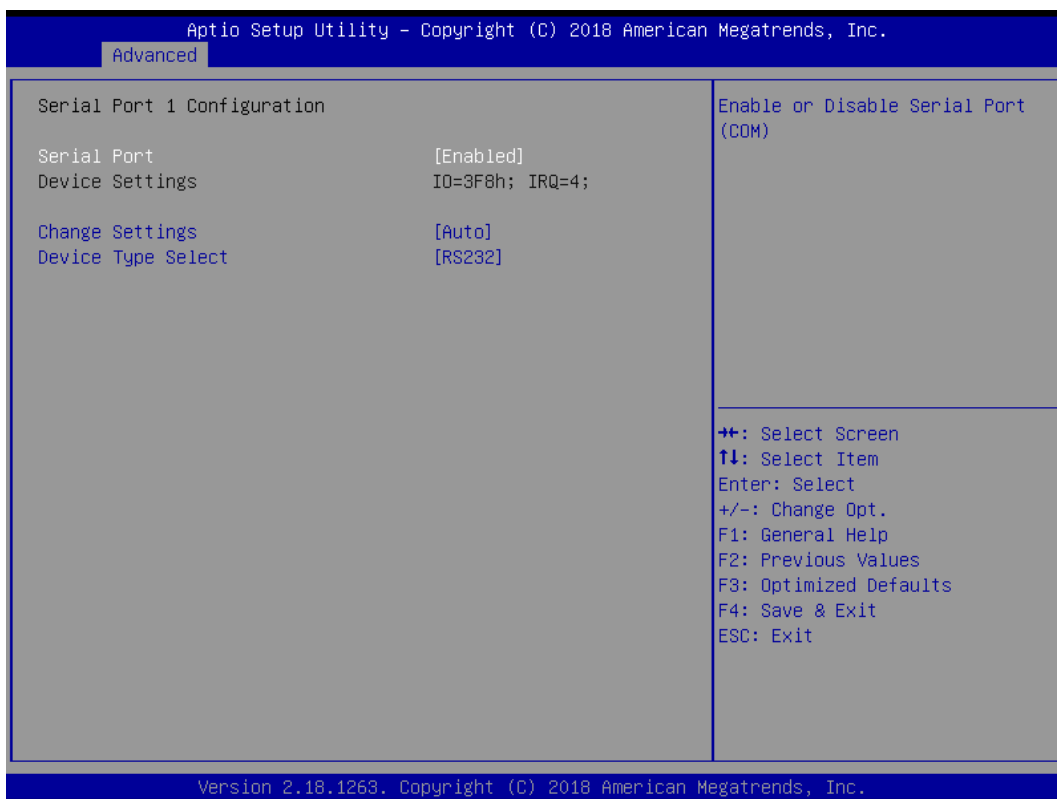

Serial Port

This item will allow users to enable or disable serial port.

Change Settings

This setting is used to change the address & IRQ settings of the specified serial port.

Device Type Select

Change the Serial interface. Select <RS232> ,<RS422> or <RS485> interface.

Serial Port 2 Configuration

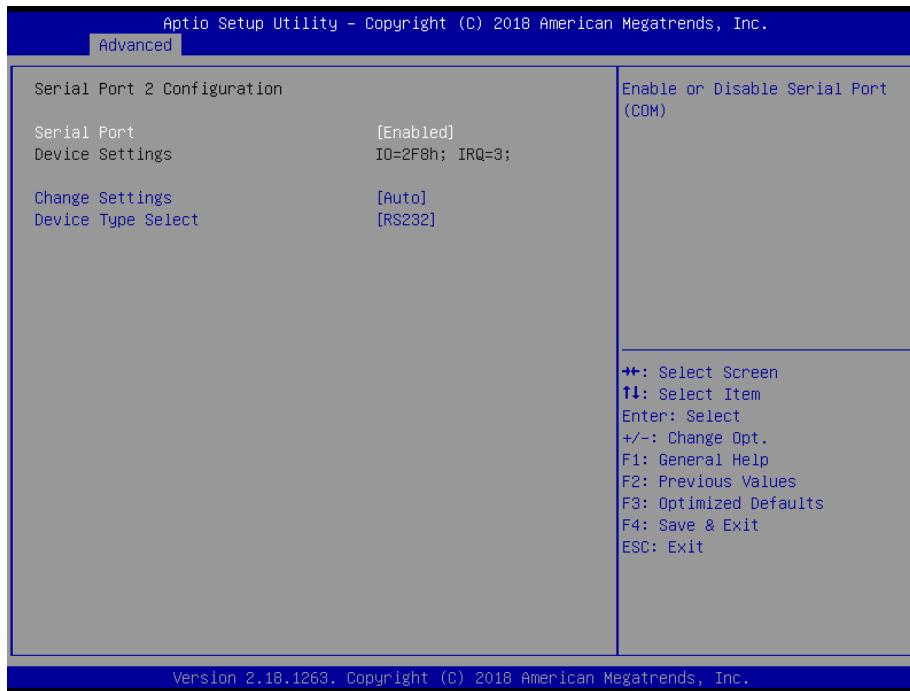

- Serial Port**
This item will allow users to enable or disable serial port.
- Change Settings**
This setting is used to change the address & IRQ settings of the specified serial port.
- Device Type Select**
Change the Serial interface. Select <RS232> ,<RS422> or <RS485> interface

Serial Port 3 Configuration

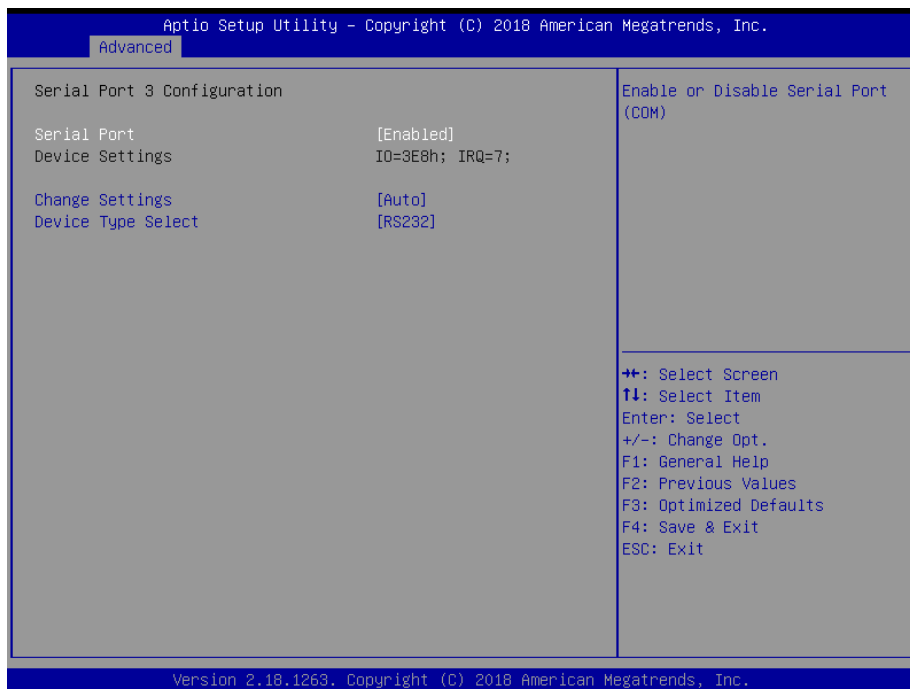

- Serial Port**
This item will allow users to enable or disable serial port.
- Change Settings**
This setting is used to change the address & IRQ settings of the specified serial port.
- Device Type Select**
Change the Serial interface. Select <RS232> ,<RS422> or <RS485> interface.

Serial Port 4 Configuration

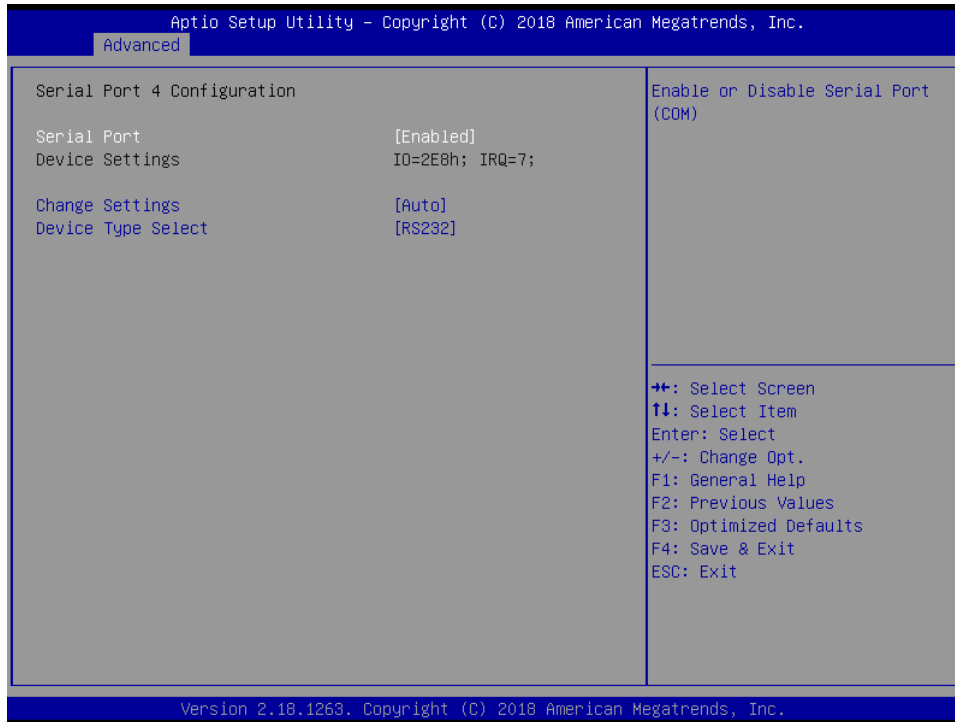

Serial Port

This item will allow users to enable or disable serial port.

Change Settings

This setting is used to change the address & IRQ settings of the specified serial port.

Device Type Select

Change the Serial interface. Select <RS232>, <RS422> or <RS485> interface.

Watch dog Timer

Watch Dog Timer Count Mode

Change the Watch dog mode. Select <Second Mode> or <Minute Mode> mode.

Watch Dog Timer Time Out Value

User can set a value in the range of 0 to 255.

4.3.8 NCT6106D HW Monitor

These items display the current status of all monitored hardware devices/components such as voltages, temperatures and all fans' speeds.

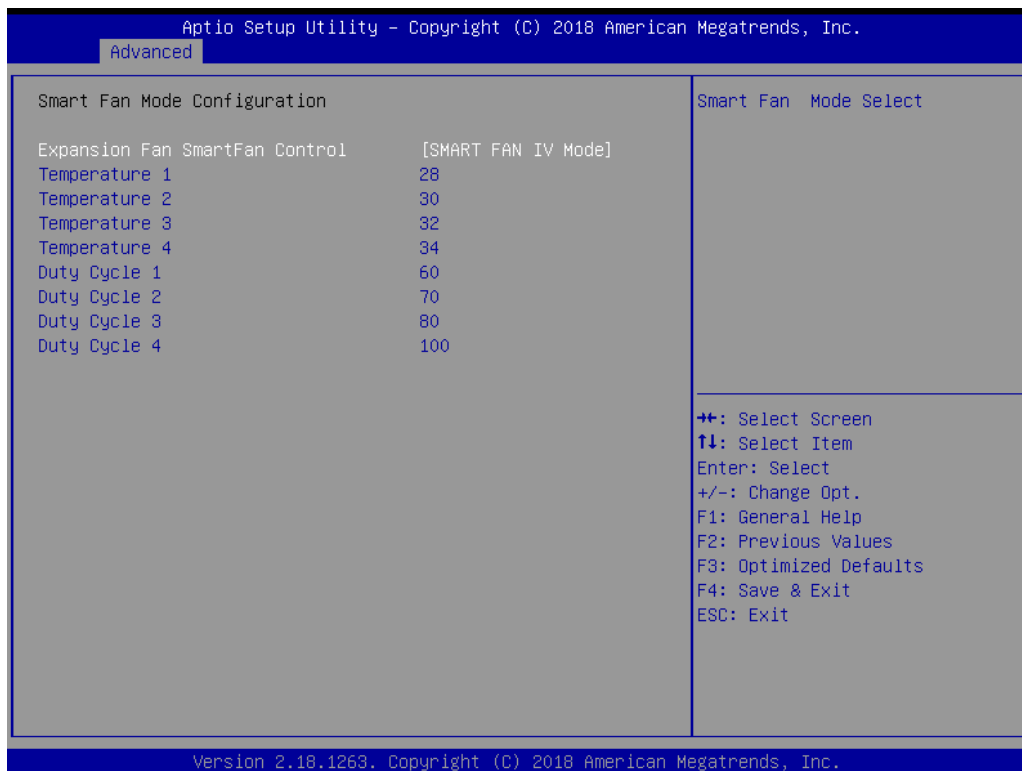
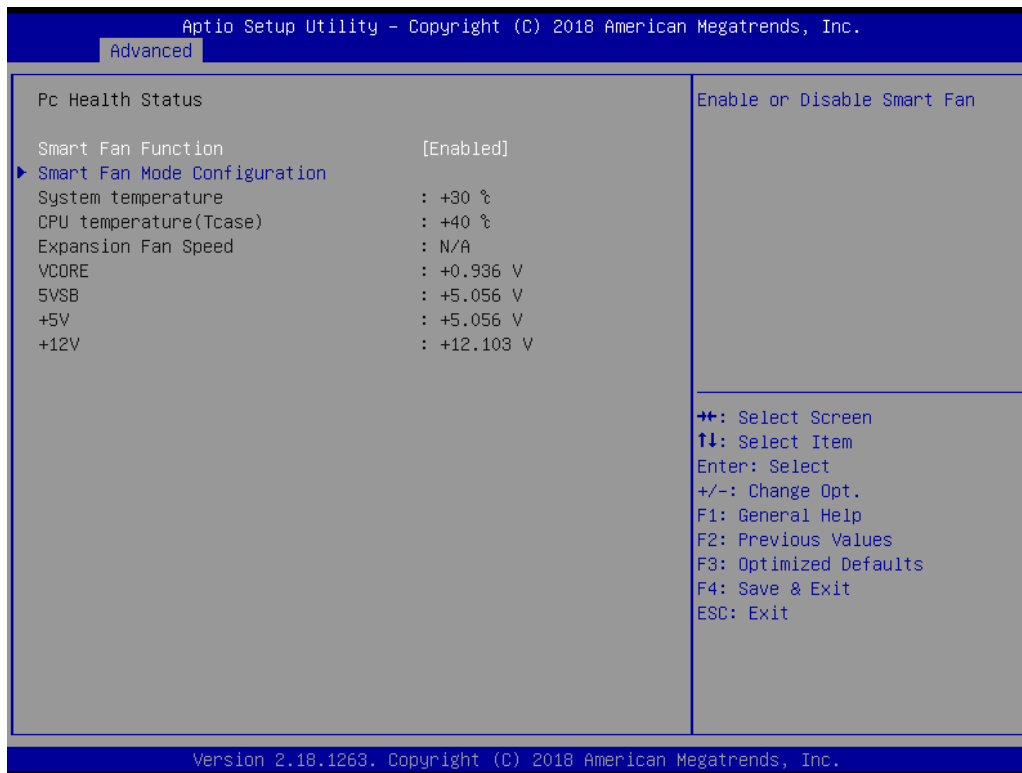

4.3.9 Serial Port Console Redirection

■ Console Redirection

This item allows users to enable or disable console redirection.



4.3.10 Network Stack Configuration



■ Network Stack

Use this item to enable or disable UEFI Network Stack.

4.3.11 CSM Configuration

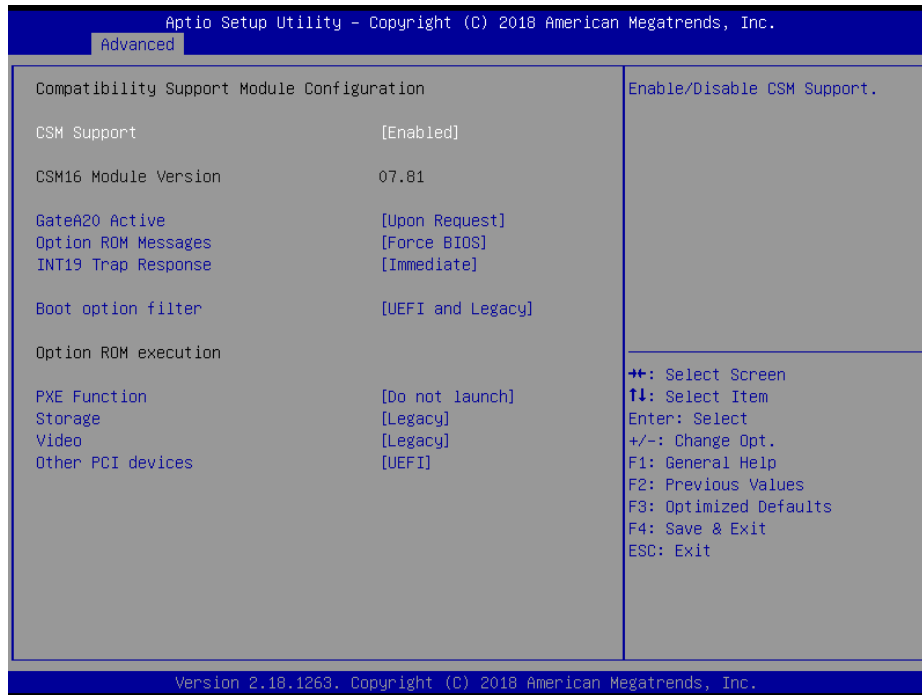

■ CSM Support

This item allows you to enable or disable CSM support.

■ GateA20 Active

This item allows you to select <Upon Request> or <Always>.

Upon Request: GA20 can be disabled using BIOS services.

Always: Do not allow GA20 disabling. This option is useful when any RT code is executed above 1MB.

■ Option ROM Messages

This item allows you to select <Force BIOS> or <Keep Current>.

Force BIOS : The third-party ROM messages will be forced to display during the boot sequence.

Keep Current : The third-party ROM messages will be displayed only if the third-party manufacturer had set the add-on device to do so.

■ INT19 Trap Response

BIOS reaction on INT19 trapping by Option ROM: Immediate - execute the trap right away; Postponed - execute the trap during legacy boot.

■ Boot option filter

This item allows you to select which type of operating system to boot.

UEFI and Legacy: Allows booting from operating systems that support legacy option ROM or UEFI option ROM.

Legacy only: Allows booting from operating systems that only support legacy option ROM.

UEFI only: Allows booting from operating systems that only support UEFI option ROM.

■ PXE Function

This item controls the execution of UEFI and PXE option ROM. Select <Do not launch>, <UEFI> or <Legacy>.

■ Storage

This setting allows you to select whether to enable the UEFI or legacy option ROM for the storage device controller. Select <Do not launch>, <UEFI> or <Legacy>.

■ Video

This setting allows you to select whether to enable the UEFI or legacy video option ROM for the video device controller. Select <Do not launch>, <UEFI> or <Legacy>.

■ Other PCI devices

This item determines option ROM execution policy for devices other than Network, storage or video. Select <Do not launch>, <UEFI> or <Legacy>.

4.3.12 USB Configuration

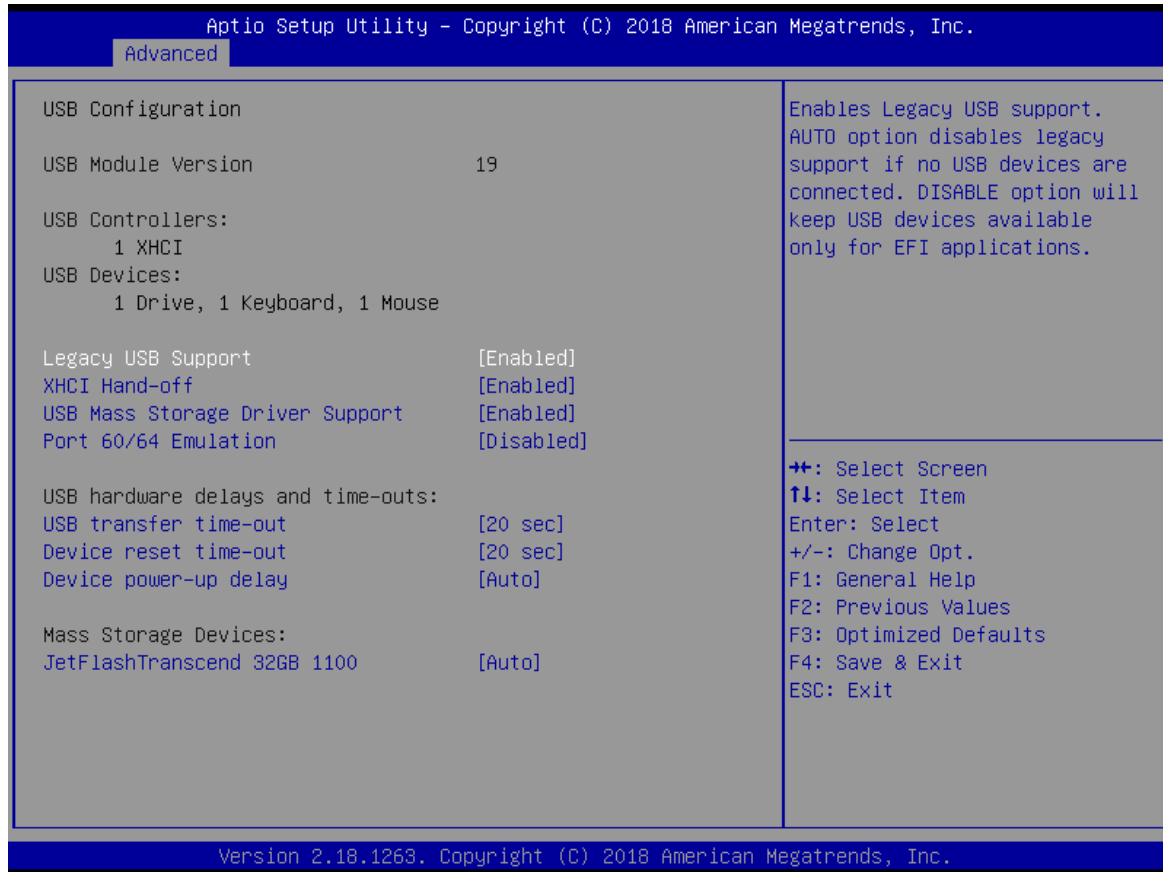

Legacy USB Support

This item allows you to select <Enabled>, <Disabled> or <Auto>.

Enabled: To enable legacy USB support.

Disabled: To keep USB devices available only for EFI specification,

Auto: To disable legacy support if no USB devices are connected.

XHCI Hand-off

This is a workaround for Oses without XHCI hand-off support. The XHCI ownership change should be claimed by XHCI driver. Select <Enabled> or <Disabled>.

USB Mass Storage Driver Support

Enables or disables support for USB storage devices.

Port 60/64 Emulation

This feature enables or disables I/O port 60h/64h emulation support. This should be enabled for complete USB keyboard legacy support for non-USB-aware Operating Systems.

USB Transfer time-out

Use this item to set the time-out value for control, bulk, and interrupt transfers. Select <1 sec>, <5 sec>, <10 sec> or <20 sec>.

Device reset time-out

Use this item to set USB mass storage device start unit command time-out. Select <10 sec>, <20 sec>, <30 sec> or <40 sec>.

Device power-up delay

Maximum time the device will take before it properly reports itself to the Host Controller. "Auto" uses default value: for a Root port it is 100ms, for a Hub port the delay is taken from Hub descriptor.

4.4 Chipset

This section allows you to configure and improve your system and allows you to set up some system features according to your preference.

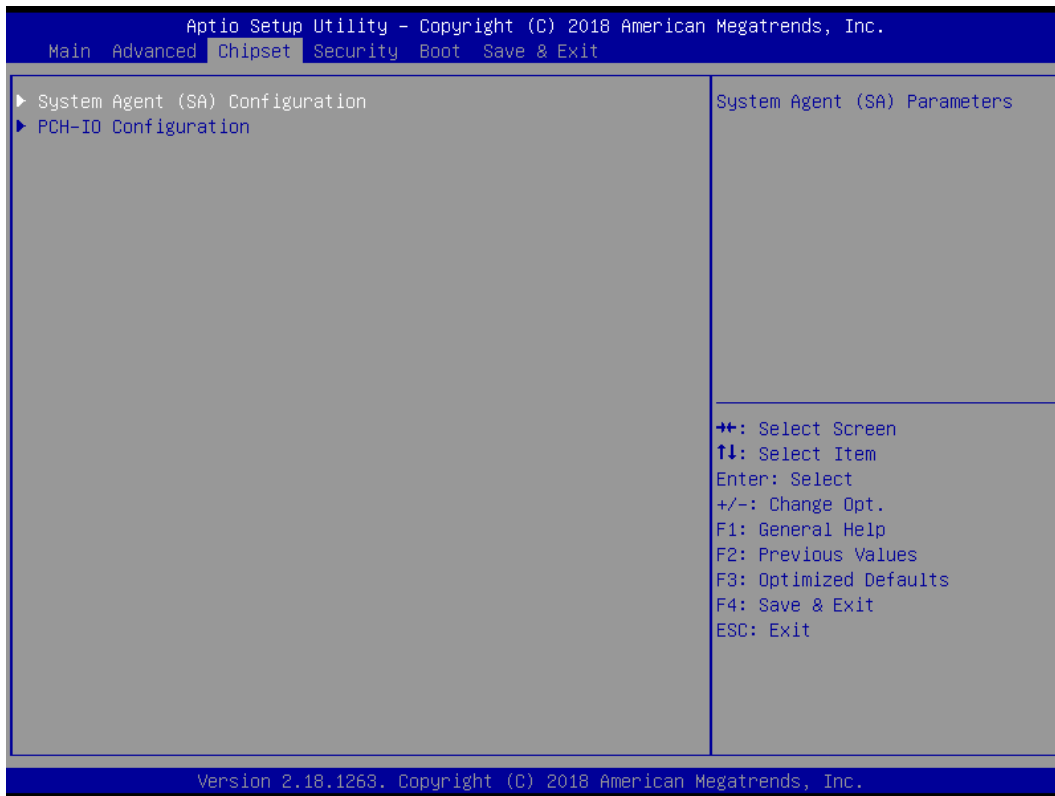

4.4.1 System Agent (SA) Configuration

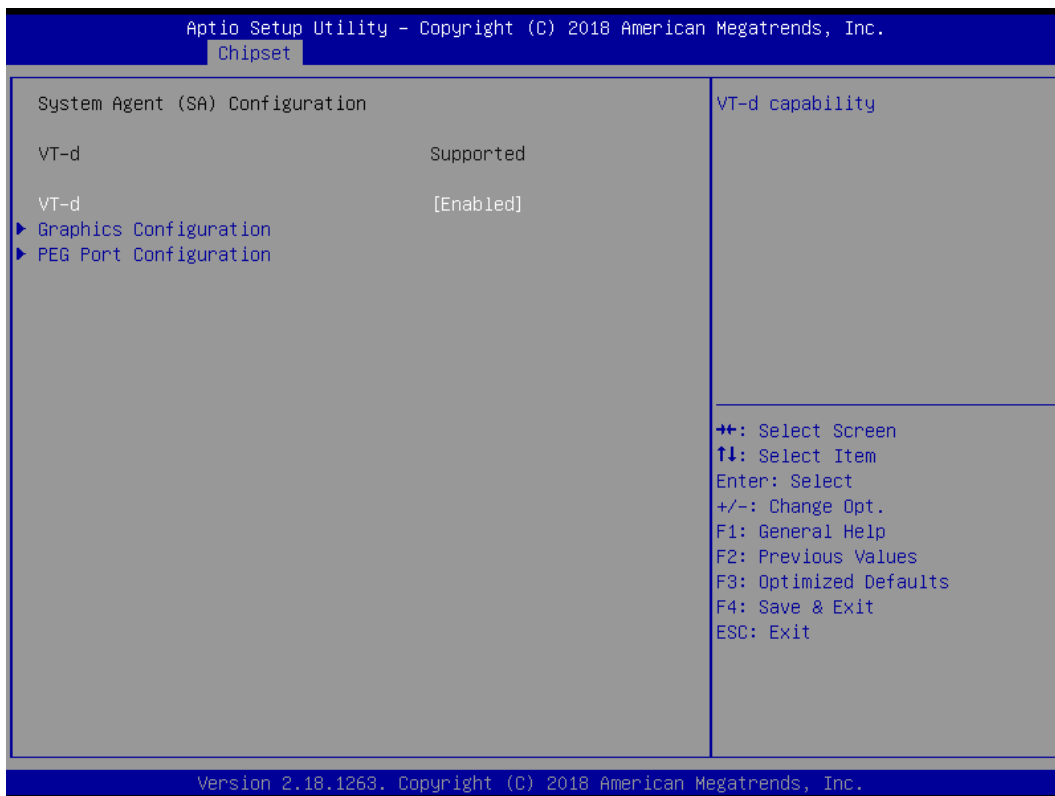

■ VT-d

This item allows users to enable or disable VT-d.

■ Graphic Configuration

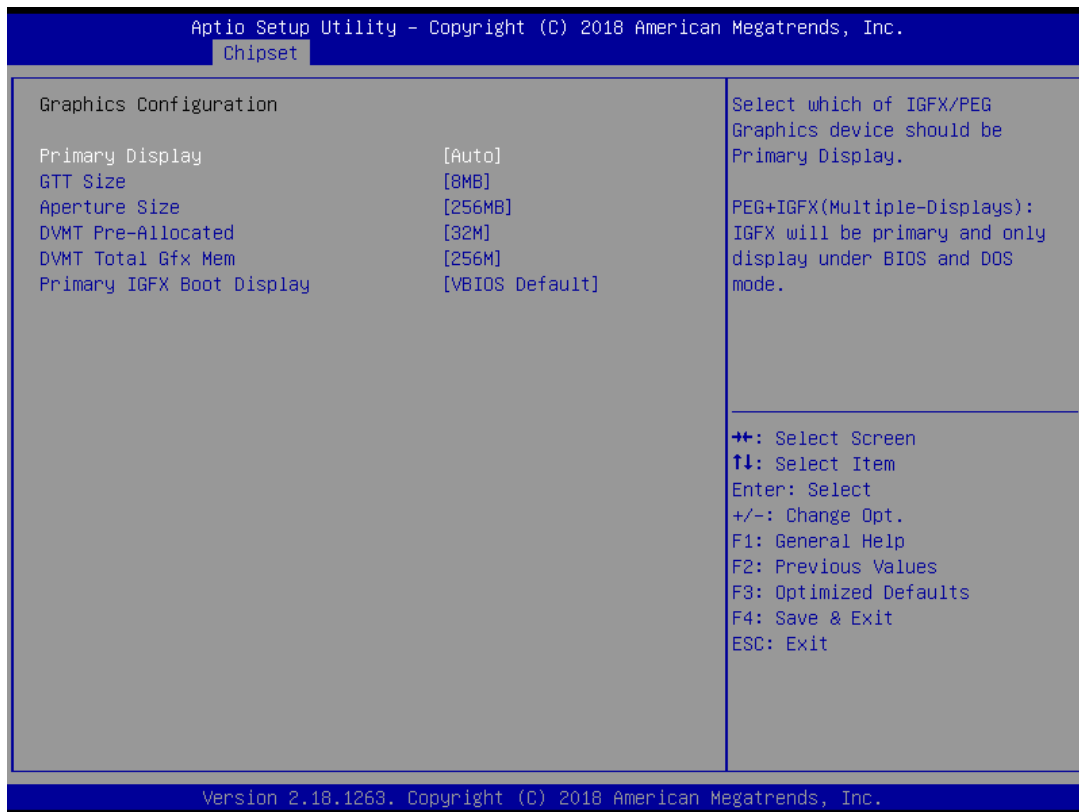

□ Primary Display

Change the Primary Display. Select <Auto> or <PEG+IGFX>

PEG+IGFX (Multiple-Displays): IGFX will be primary and only display under BIOS and DOS mode

□ GTT Size

This item allows you to change the GTT size.

□ Aperture Size

Aperture size optimal between 128MB, 256MB, 512MB, 1024MB, 2048MB or 4096MB.

□ DVMT Pre-Allocated

DVMT pre-allocated (fixed) Graphics memory size optimal from 32M to 2048M.

□ DVMT Total Gfx Mem

DVMT Total Gfx Mem optimal Between 128M, 256M or MAX.

□ Primary IGFX Boot Display

Use the field to select the type of device you want to use as the display(s) of the system.

■ PEG Port Configuration

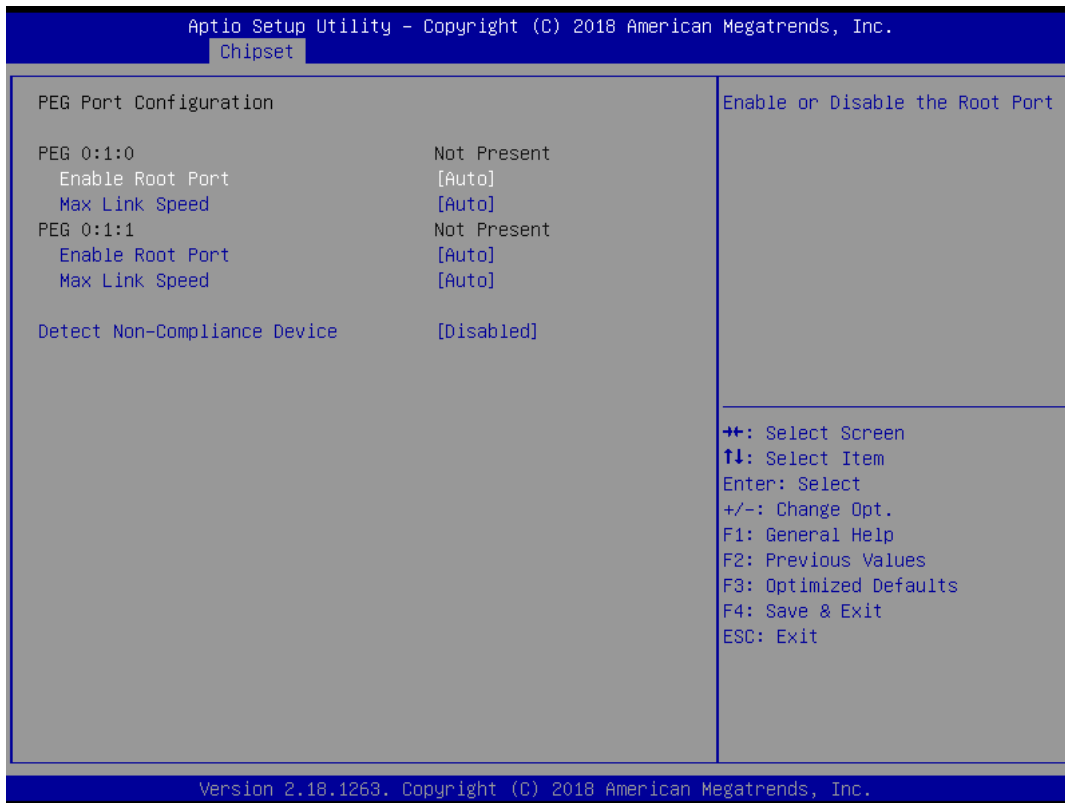

□ PEG 0:1:0

✓ Enable Root Port

This item allows you to enable or disable the Root Port.

✓ Max Link Speed

This item allows you to configure PEG 0:1:0 Max Sped.

□ PEG 0:1:1

✓ Enable Root Port

This item allows you to enable or disable the Root Port.

✓ Max Link Speed

This item allows you to configure PEG 0:1:1 Max Sped.

□ Detect Non-Compliance Device

Detect Non-Compliance PCI Express Device. If enable, it will take more time at POST time.

4.4.2 PCH-IO Configuration

This section allows you to configure the chipset.

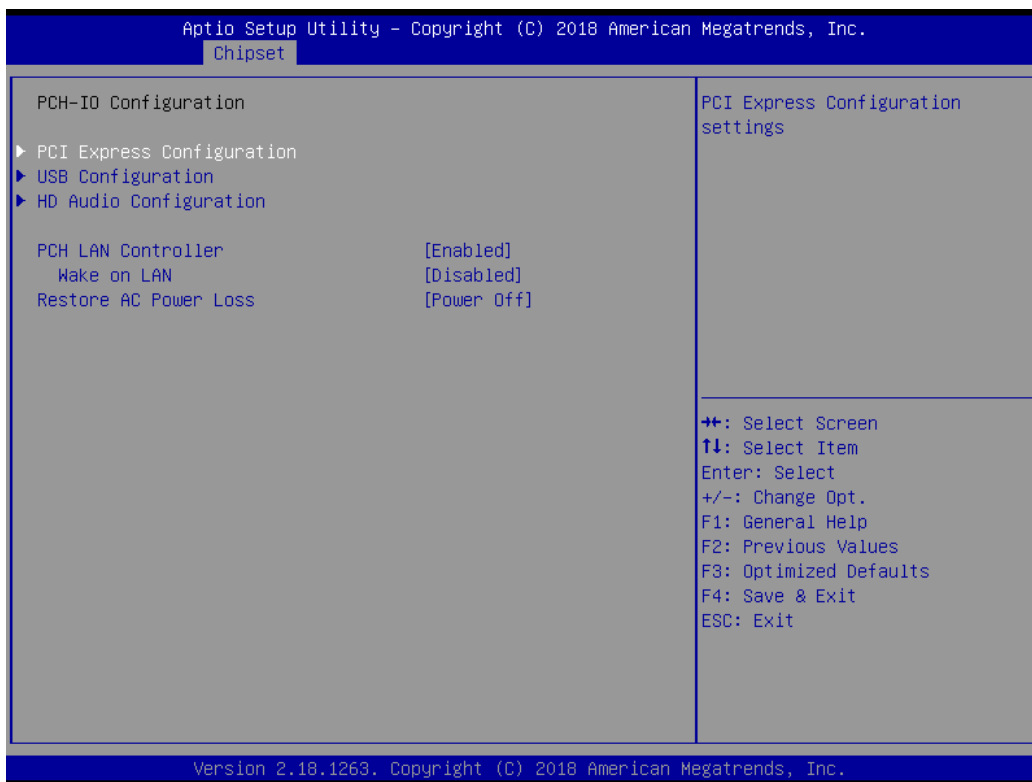

■ PCI Express Configuration

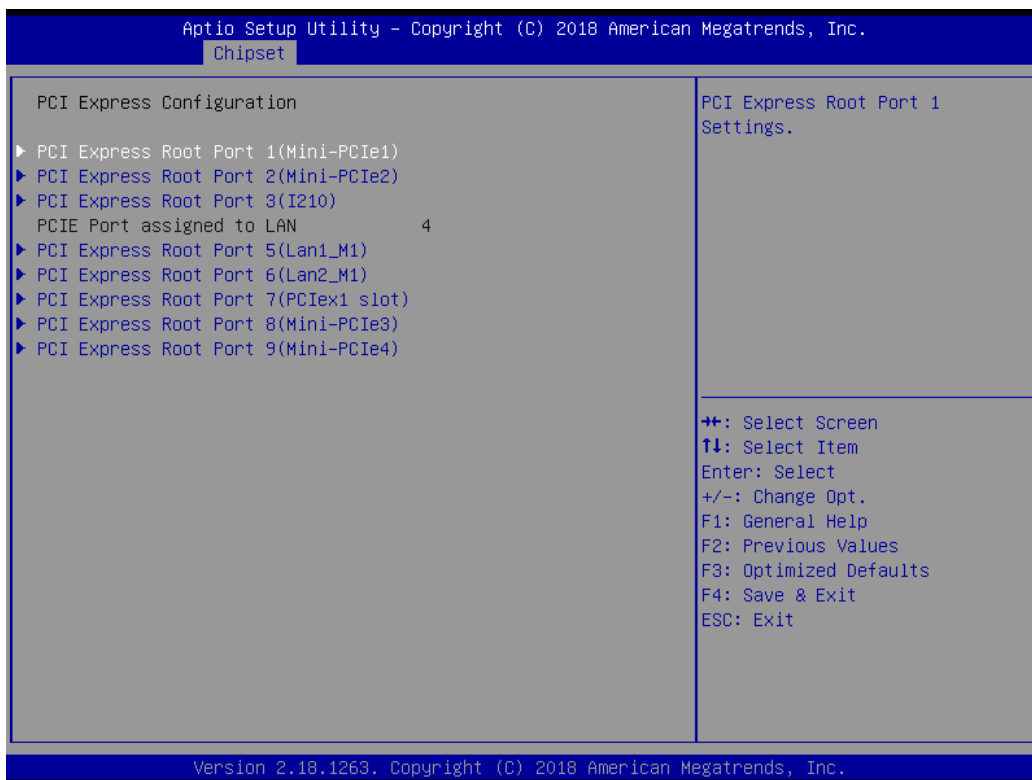

❑ PCI Express Root Port 1 / 3 / 4 / 5 / 6 / 7 / 8 / 9

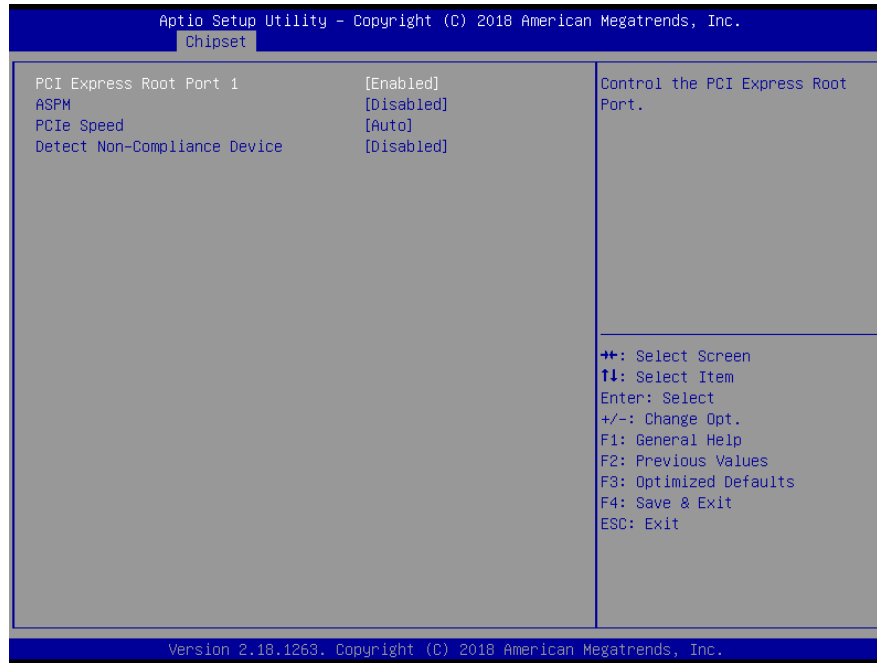

✓ PCI Express Port 1 / 3 / 4 / 5 / 6 / 7 / 8 / 9

This item allows you to enable or disable PCI Express Port 1 / 3 / 4 / 5 / 6 / 7 / 8 / 9 in the chipset.

✓ ASPM

This item allows you to select the ASPM state for energy-saving. Select <Disabled> ,<L0s> ,<L1> ,<L0sL1> or <Auto>

✓ PCIe Speed

Change the PCIe Port Speed. Select <AUTO> ,<Gen 1> or <Gen 2>

✓ Detect Non-Compliance Device

Detect Non-Compliance PCI Express Device. If enable, it will take more time at POST time.

■ USB Configuration



❑ XHCI Disable Compliance mode

Options to disable compliance mode. Default is FALSE enable compliance mode. Set TRUE to disable compliance mode.

❑ xDCI Support

This item will allow users to enable or disable xDCI Support.

■ HD Audio Configuration

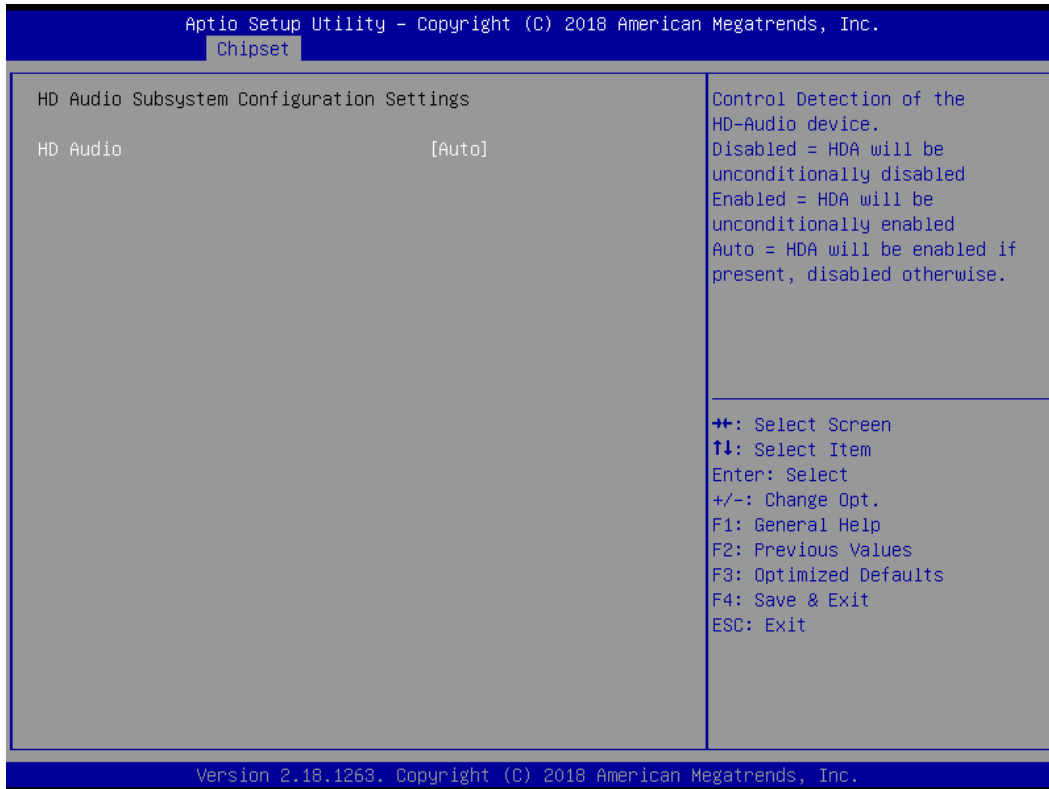

□ HD Audio

Control detection of the HD-Audio device. This item allows you to select <Enabled>, <Disabled> or <Auto>.

Disabled: Azalia will be unconditionally be disabled.

Enabled: Azalia will be unconditionally be enabled.

Auto: Azalia will be enabled if present, disabled otherwise.

4.5 Security

Security menu allow users to change administrator password and user password settings.

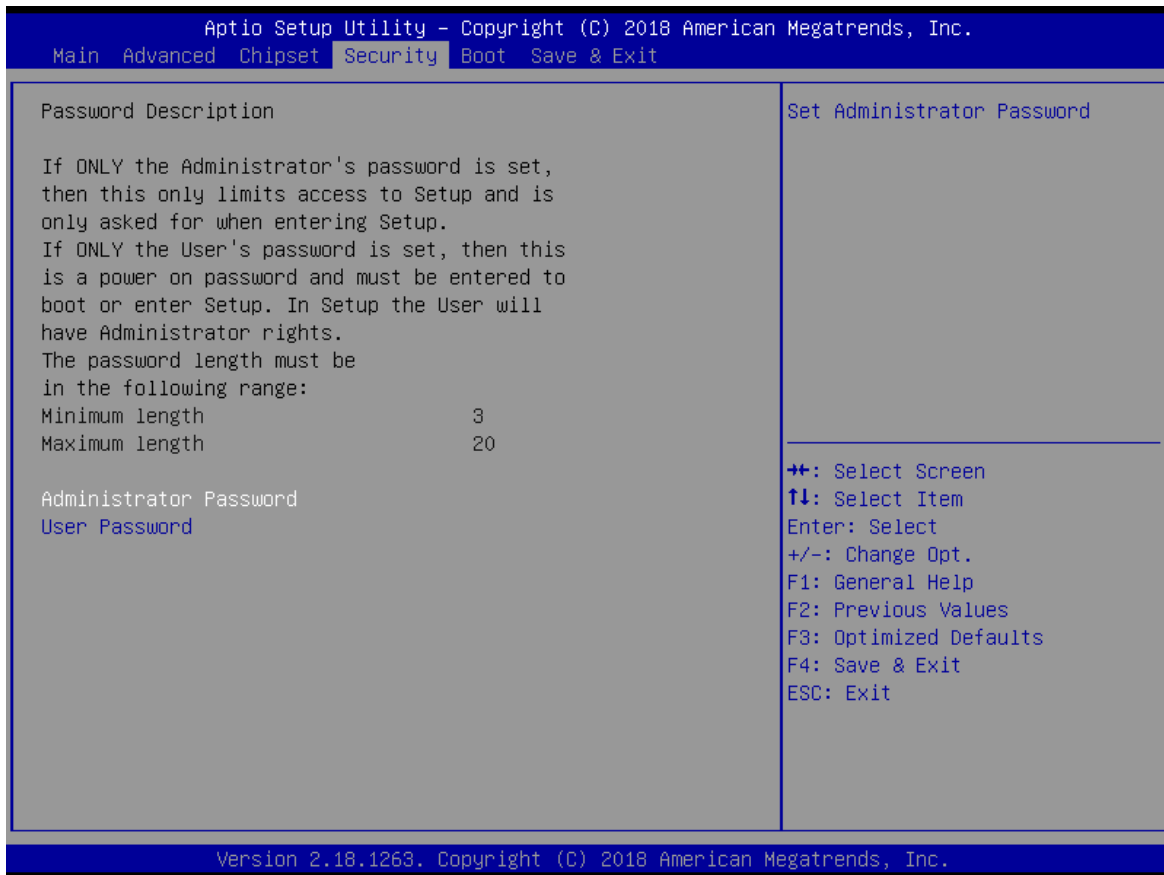

■ Administrator Password

This item allows you to set Administrator Password.

■ User Password

This item allows you to set User Password.

4.6 Boot

This menu allows you to setup the system boot options.

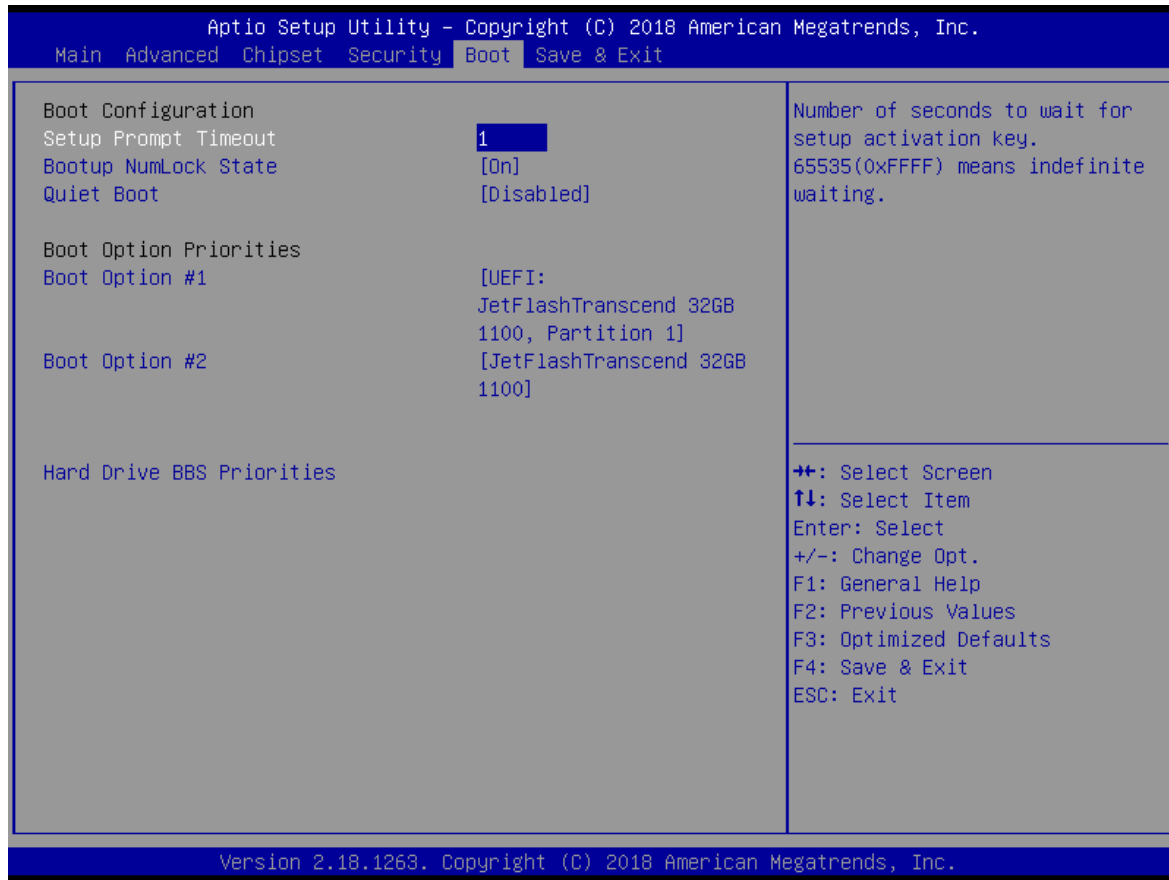

■ Setup Prompt Timeout

This item sets number of seconds to wait for setup activation key.

■ Bootup NumLock State

This item selects the keyboard NumLock state. Select <On> or <Off>.

■ Full Screen Logo Show

This item allows you to enable or disable Full Screen Logo Show function.

■ Hard Driver BBS Priorities

The items specify the boot device priority sequence from the available devices. The number of device items that appears on the screen depends on the number of devices installed in the system.

4.7 Save & Exit

This setting allows users to configure the boot settings.

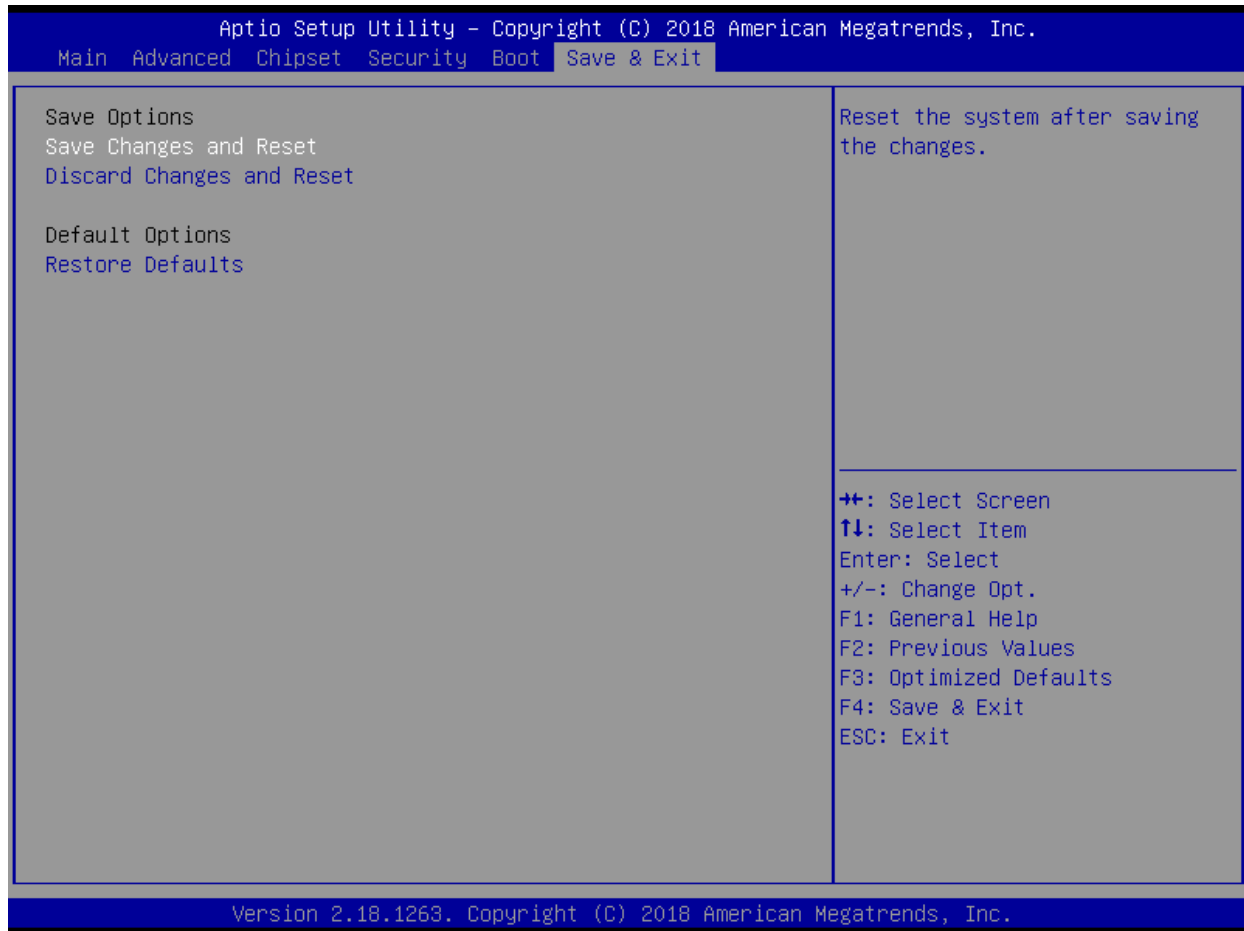

■ Save Changes and Reset

This item allows user to reset the system after saving the changes. This item allows user to reset the system after saving the changes.

■ Discard Changes and Reset

This item allows user to reset the system without saving any changes.

■ Restore Defaults

Use this item to restore /load default values for all the setup options.

Appendix

WDT & GPIO

This appendix provides the sample codes of WDT (Watch Dog Timer) and GPIO (General Purpose Input/ Output).

WDT Sample Code

WDT Setting

Psuedo Code

```
#define AddrPort          0x2e
#define DataPort         0x2f
#define SIO_UnLock_Value 0x87
#define SIO_Lock_Value   0xaa
#define WATCHDOG_LDN    0x07
#define GPIO_Port        0xF1

//Enter_Config
WriteByte (AddrPort, SIO_UnLock_Value);
WriteByte (AddrPort, SIO_UnLock_Value);

//Enter WATCHDOG LDN
WriteByte (AddrPort, 0x07);
WriteByte (DataPort, WATCHDOG_LDN);

//Set count mode
WriteByte (AddrPort, 0xf0);
buf2 = ReadByte (DataPort) & 0xf4; //clear "Select Watchdog Timer I count mode
buf2 |= 0x02; //Enable the Watchdog Timer I output low pulse to the KBRST# pin
// buf2 |= 0x08; //Bit3 = (1:Minute Mode/0:Second Mode)
WriteByte (DataPort, buf2); //Write back

//Set watch dog time value
WriteByte (AddrPort, 0xf1)
WriteByte (DataPort, Time) //Set watch dog time value

// close config mode
WriteByte (AddrPort, 0xaa);
```

GPIO Sample Code

GPIO Setting

PIN#	GPIO#	Default Configuration
18	XCOM-	
17	XCOM+	
16	OUT8	DIO Output8
15	IN8	DIO Input8
14	OUT7	DIO Output7
13	IN7	DIO Input7
12	OUT6	DIO Output6
11	IN6	DIO Input6
10	OUT5	DIO Output5
9	IN5	DIO Input5
8	OUT4	DIO Output4
7	IN4	DIO Input4
6	OUT3	DIO Output3
5	IN3	DIO Input3
4	OUT2	DIO Output2
3	IN2	DIO Input2
2	OUT1	DIO Output1
1	IN1	DIO Input1

The GPIO function is provided by Nuvoton NCT6106D, and it can be accessed through its GPIO index/data port. To access the GPIO register, write index to the index port, and then read/write from/to data port. The configuration on the RCO-6000 is described as below.

Pseudo Code

```
#define AddrPort          0x2e
#define DataPort         0x2f
#define SIO_UnLock_Value 0x87
#define SIO_Lock_Value   0xaa
#define SIO_LDN_GPIO     0x07
#define GPIO_Port        0xF1
```

```
//Enter_Config
WriteByte (AddrPort, SIO_UnLock_Value);
WriteByte (AddrPort, SIO_UnLock_Value);
```

```
WriteByte (AddrPort, 0x07);
WriteByte (DataPort, SIO_LDN_GPIO);
```

```
//Set OUT1~OUT8Value
WriteByte (AddrPort, GPIO_Port);
WriteByte (DataPort, 0x00); //set OUT1~OUT8 value, OUT1=Bit0, OUT2=Bit1
```

Bit 7	Bit 6	Bit 5	Bit 4	Bit 3	Bit 2	Bit 1	Bit 0
OUT8	OUT7	OUT6	OUT5	OUT4	OUT3	OUT2	OUT1

```
// Read In1~In8 value
WriteByte (AddrPort, 0xED);
Data= ReadByte (DataPort); //Read In1~In8 value
```

Bit 7	Bit 6	Bit 5	Bit 4	Bit 3	Bit 2	Bit 1	Bit 0
IN8	IN7	IN6	IN5	IN4	IN3	IN2	IN1

```
// close config mode
WriteByte (AddrPort, SIO_Lock_Value);
```

